



DANISH
TECHNOLOGICAL
INSTITUTE

Energy and Climate
Refrigeration and Heat Pump Technology

Energy Efficient Ammonia Heat Pump

PSO no. 342-059

Claus Madsen
Bastiaan Pijnenburg
Henning Schumann Grindorf
Rolf Christensen
Bjarne D. Rasmussen
Søren Gram
Dan Fredborg Jakobsen

Title: Energy Efficient Ammonia Heat Pump

PSO no. 342-059

Prepared by: Danish Technological Institute, Kongsvang Allé 29, DK-8000 Aarhus C,
Energy and Climate, Refrigeration and Heat Pump Technology

Contact: Claus Madsen, e-mail: clma@teknologisk.dk

September 2013

Authors:

Claus Madsen, Danish Technological Institute
Bastiaan Pijenburg, Danish Technological Institute
Henning Schumann Grindorf, Danish Technological Institute
Rolf Christensen, Alfa Laval
Bjarne D. Rasmussen, Grundfos
Søren Gram, Svedan Industri Køleanlæg
Dan Fredborg Jakobsen, Svedan Industri Køleanlæg

Table of Contents

1. Abstract	5
2. Introduction.....	6
3. Description of the Concept of the Split Condenser.....	7
3.1. Introduction	7
3.2. The Basic System with one Condenser and possible Sub-Cooler	7
3.3. The Novel System with a Split Condenser.....	8
3.4. Influence of Compressor Type.....	14
4. Simulation with EES and CAS 2000	15
5. Description of Liquid Separator / U-Turn (Alfa Laval)	17
5.1. U-Turn and Evaporator	17
5.2. U-Turn Separator Vessel	20
5.3. Optimum Circulation Rate.....	22
6. Description of Laboratory Test Unit.....	25
6.1. Ammonia System	25
6.2. Liquid System	26
6.3. Main Components.....	28
6.4. Control System	30
6.5. COP Calculation.....	30
7. Test Results with Novel Ammonia Heat Pump.....	32
7.1. Purpose of the Tests	32
7.2. Description of Test Unit.....	32
7.3. Functional Tests	32
7.4. Performance Tests.....	33
7.5. Results.....	35
7.5.1. Test 3: 33.3% Capacity, Serial Connection (Q1 & Q2), no (Q3), no (Q4).....	35
7.5.2. Test 2d: 33.3% Capacity, Serial Connection (Q1 & Q2), including (Q3) and (Q4)	36
7.5.3. Test 4: 33.3% Capacity, Parallel Connection (Q1 & Q2), including (Q3) and (Q4), 100°C from (Q1).....	36
7.5.4. Test 5: 33.3% Capacity, Parallel Connection (Q1 & Q2), including (Q3) and (Q4), Varying Distribution between (Q1) and (Q2).....	37
7.5.5. Test 7d: 60% Capacity, Serial Connection (Q1 & Q2), including (Q3) and (Q4)	38
7.5.6. Test 7c: 60% Capacity, Parallel Connection (Q1 & Q2), including (Q3) and (Q4), 100°C from (Q1).....	39

7.5.7. Test 8: 60% Capacity, Parallel Connection (Q1 & Q2), including (Q3) and (Q4), Varying Distribution between (Q1) and (Q2).....	40
7.5.8. Test 7a-c: 60% Capacity, Variation of Liquid Level in the Drop Leg of (Q5)	41
7.5.9. Test 6b: 48% Capacity, Pump Operation with Varying Differential Pressure	42
7.6. Conclusion Regarding Test Results.....	43
8. Final Discussion.....	45
Appendix A	
Appendix B	
Appendix C	

1. Abstract

The report describes the development of a highly effective ammonia heat pump through a project supported by the Danish ELFORSK program. Heat pumps play an increasingly important role in the search for more effective use of energy in our society. Highly efficient heat pumps can contribute to reduced energy consumption and improved economy of the systems which they are a part of.

An ammonia heat pump with high pressure reciprocating compressor and a novel split condenser was developed to prove potential for efficiency optimization. The split of the condenser in two parts can be utilized to obtain smaller temperature approaches and, thereby, improved heat pump efficiency at an equal heat exchanger area, when compared to the traditional solution with separate condenser and de-superheater. The split condenser design can also be exploited for heating a significant share of the total heating capacity to a temperature far above the condensing temperature.

Furthermore, the prototype heat pump was equipped with a plate type evaporator combined with a U-turn separator with a minimum liquid height and a liquid pump with the purpose of creating optimum liquid circulation ratio for the highest possible heat transfer coefficients at the lowest possible pressure drop.

The test results successfully confirmed the highest possible efficiency; a COP of 4.3 was obtained when heating water from 40°C to 80°C while operating with evaporating/condensing temperatures of +20°C/+73°C.

2. Introduction

The project is supported by the Danish ELFORSK program.

During the project, an ammonia heat pump with a heating capacity of approximately 380kW has been built by Svedan Industri Køleanlæg.

The unit consists of a Mycom high pressure reciprocating compressor and an Alfa Laval flooded plate heat exchanger with a U-turn separator for the evaporator side. Circulation of the ammonia liquid in the evaporator occurs in terms of either natural circulation or a Grundfos refrigerant pump.

One goal of the project is to show the potential of splitting the condenser into two parts and under which circumstances this is possible. For this purpose, the unit is built up with two Alfa Laval condensers of which the first condenser also functions as de-superheater.

With a relatively large difference in temperature of water in and out of the condenser, it is possible to reduce the required area of the condenser by splitting it into two parts. An alternative is to use the same area but increase the COP by lowering the condensing temperature.

The main heat recovery comes from the two condensers and a sub cooler. The heat from the compressor cylinder heads and the oil cooling system is also regained into the hot water flow.

The system is designed to operate with a nominal condensing temperature of 74°C and it heats water from 40°C to 80°C on the hot side. On the cold side, the nominal evaporating temperature is designed for 22°C and the water is cooled from 30°C to 25°C.

Another goal is to find the optimum compromise between refrigerant pressure drop and heat transfer coefficients.

Furthermore, the pump can enable the placement of the separator directly above the compact heat exchanger, whereby the pressure drop in the return line is avoided.

3. Description of the Concept of the Split Condenser

3.1. Introduction

By splitting the condenser into two parts and optimizing water flows and temperature programs for the condensers, one gains a potential for reducing the condensation temperature. Substantial energy savings can be reached in cases where the waterside temperature rise is high. Optimized design of the condensers may also reduce the required total heat transfer surface.

This report shows that high efficiency heat pumps do not necessarily need to be equipped with an extensive heat exchanger area. For applications with a high waterside temperature rise, the splitting of the condenser into two parts provides the opportunity to either increase efficiency by reducing the condensing temperature or reduce costs by reducing the total heat exchanger area.

The report describes different ways of heating water with an ammonia heat pump from 40°C to 80°C on the hot side, while cooling water from 30°C to 25°C on the cold side (the evaporator). A TS diagram is used to illustrate the basic process of the refrigerant and the waterside of the system. The basic system layout is illustrated in Figure 1.

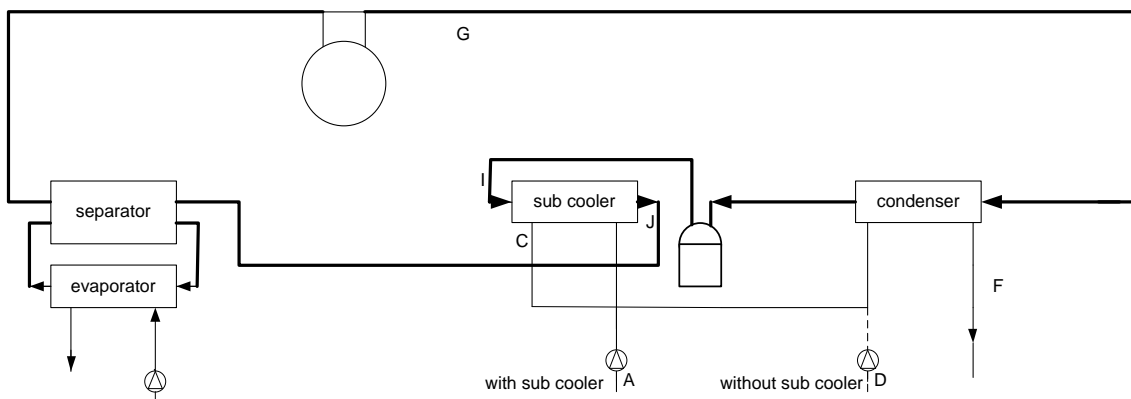

Figure 1: Simplified description of the heat pump

3.2. The Basic System with one Condenser and possible Sub-Cooler

The simplest way to heat the water is to only use the condenser. In the TS diagram shown in Figure 2, the water is heated according to the straight line from D to F, while the refrigerant is cooled according to the lines from G to H (de-superheating) and from H to I (condensing). Here, it is already seen that higher discharge gas temperatures reduce the necessary condensing temperature, when assuming a constant minimum temperature difference at the pinch point (H).

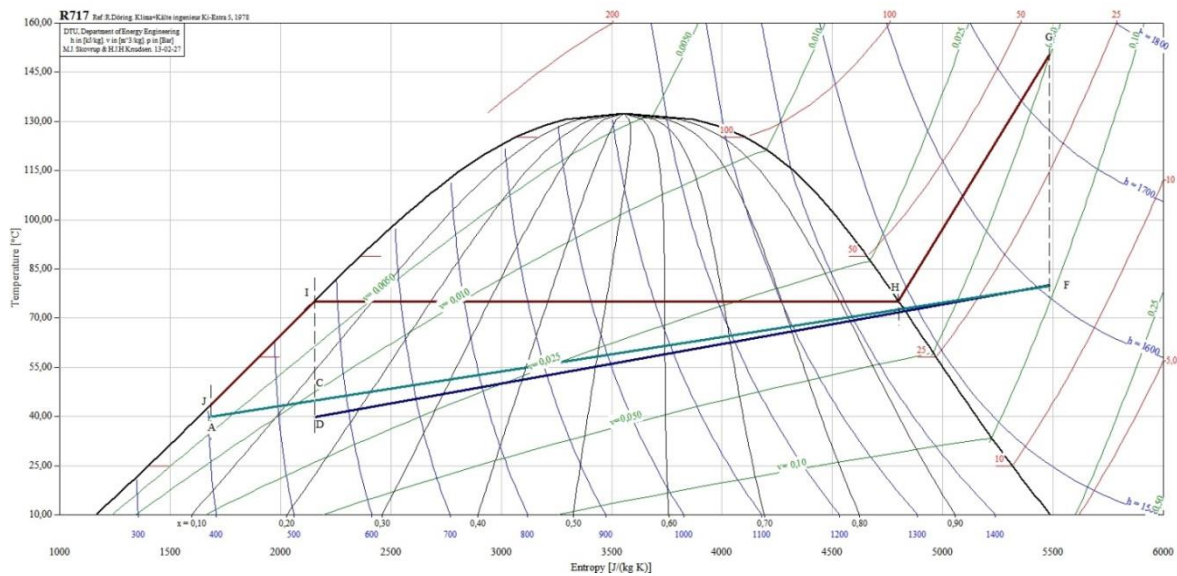

Figure 2: Diagram for the standard heat pump cycle

The first improvement can be made by using the heat from sub cooling the refrigerant to preheat the water. The sub cooling of the refrigerant is indicated by the line from I to J. Initially, the water flows through the sub cooler illustrated by the line from A to C. After the preheating, the water flows through the condenser illustrated by the line from C to F. The TS diagram makes it clear that the condensing temperature will rise slightly, if a constant minimum temperature difference in the pinch point (H) is assumed. However, since a considerable amount of heat now comes from the sub cooler, the total quantity of circulated refrigerant (mass flow) can be reduced at the same time. In total, the use of sub cooling will reduce the necessary compressor work and thereby improve the total efficiency of the heat pump.

3.3. The Novel System with a Split Condenser

Today, the splitting of the condenser into two parts is already very common as separate heat exchangers for de-superheating (line G-H) and condensing (line H-I) of the refrigerant are often seen, see Figure 2. Not only in connection with heat pumps, but also in connection with normal refrigeration plants, this split is used to heat up water, for example for cleaning purposes.

However, this report focuses on splitting the condenser into two parts, mainly for the purpose of reducing the total heat exchanger area. Another possible application could be the heating of two independent water flows with one of the outlet temperatures being above the condensing temperature. Figure 3 illustrates the layout of the system with the split condenser.

The total water flow and the total heating effect are unchanged compared to the previous example with one condenser. The water that flows through both condensers (part I and part II) is mixed downstream of the condensers, and the result is an outlet water temperature at 80°C as in the previously described case. Initially, the condensing temperature is the same and, as can be seen from the diagram, partial condensation takes place in the first condenser (part I).

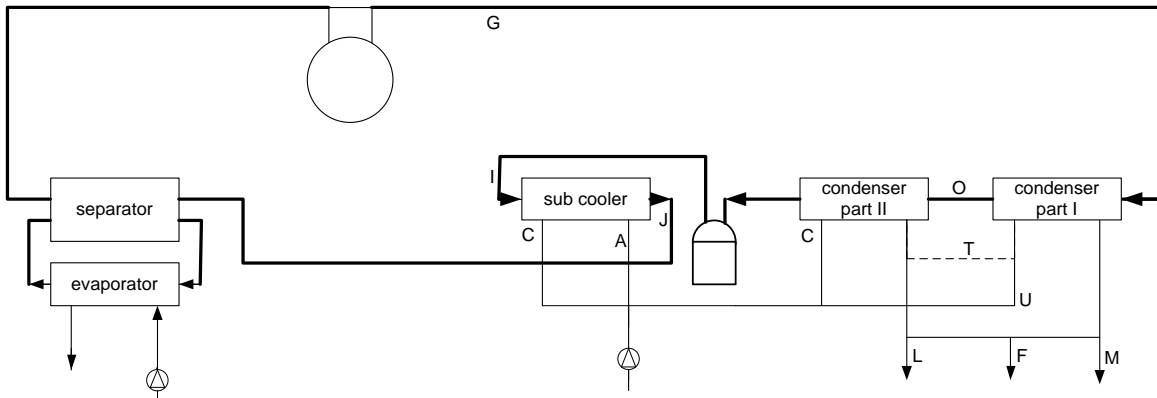

Figure 3: Layout of the heat pump with split condenser

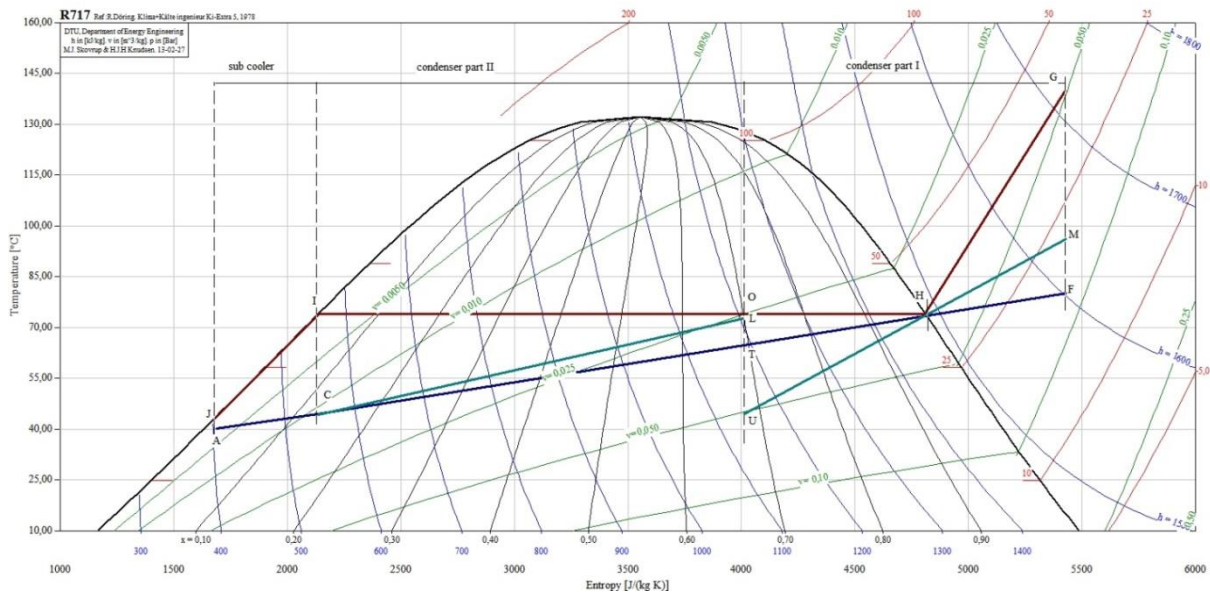

Figure 4: TS diagram of the heat pump with split condenser

The vertical line in the TS diagram in Figure 4 indicates the separation of the two condensers. As can be seen from the diagram, moving the vertical line to the left or right will result in a different water temperature out of the first condenser (part I) under the assumption of a constant temperature differences in the pinch points. The water temperature out of the system (point N) is 80°C and it is the same as in the previously described system with one condenser (corresponding point F).

When compared to a solution with a single condenser, the split condenser solution enables us to reduce either the total heat exchanger area for the same condensing temperature or the condensing temperature for the same total area.

Figure 5 shows the necessary heat exchanger area indicated by the number of plates as a function of the condensing temperature. The area of sub cooling is not considered for the case of simplicity.

The graph in Figure 5 shows that the necessary area and, thus, the heat exchanger cost increase drastically when the temperature difference in the pinch point is reduced. The water temperature at the pinch point in this case is 72.2°C.

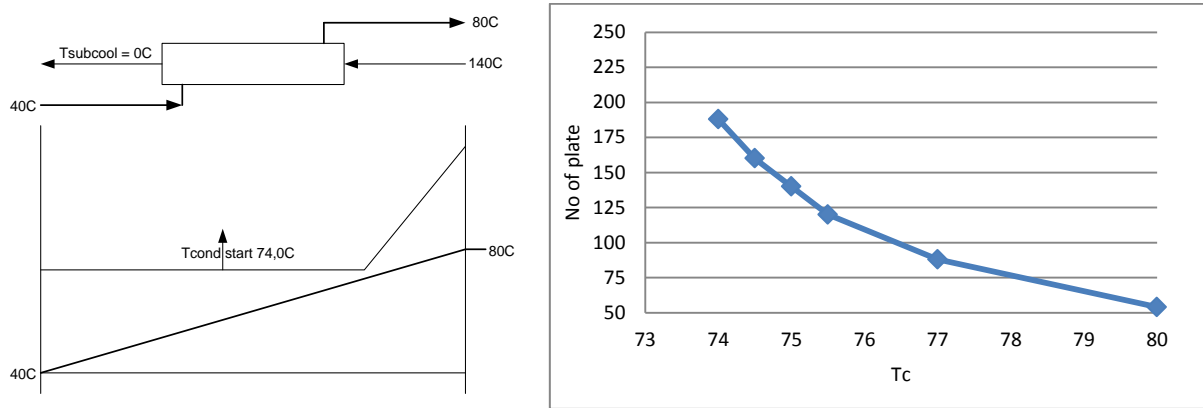

Figure 5: Heat exchanger area for single condenser

In the following, the condenser is divided into two parts, as described earlier, and equal temperature differences at the pinch point are assumed for both parts. Figure 6 shows the total area (number of plates) of both heat exchangers. With the mentioned temperature levels, the split of the condensers results in a vapor mass fraction of 70% ($x = 0.7$) for the refrigerant leaving condenser part I.

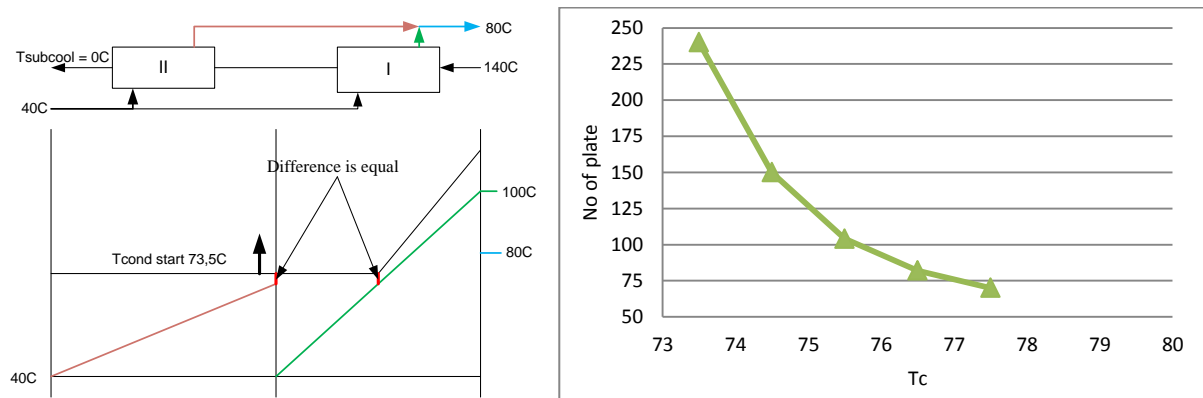

Figure 6: Heat exchanger area of split condenser

When comparing the results from Figure 5 and 6, it becomes clear that the total number of plates, and thus the total heat exchanger area, is somewhat similar. Splitting the condenser into two parts enables the use of different designs of the two heat exchangers (plate geometry), but even with an identical design the total area will not be exactly the same as the total area of the single condenser. Moreover, the position of the split may also be of influence. An explanation of these facts will not be dealt with in this report.

The question is what will happen, if equal temperature differences in the pinch points for the two parts are no longer required. With a simple thermodynamic study, it is possible to show what happens with the condensing temperature, if the temperature difference in the two pinch points is changed while keeping the same total heating capacity. The heat exchanger area is not part of this calculation, but instead it is based on simple energy balance over the heat exchangers.

Figure 7 shows what happens to the minimum necessary condensing temperature when the pinch point temperature differences are changed.

The curve indicated by " $T_{c_I_DT}=1,2$ " shows that the temperature difference in the pinch point for condenser part I is constant at 1.2K, while the temperature difference in the other condenser (part II) is varied. The opposite goes for the curve indicated by " $T_{c_II_DT}=1,2$ " where condenser part II has a constant temperature difference.

In all cases, the mixed water outlet temperature is 80°C and the water outlet temperature for condenser part I is 100°C. As seen in Figure 7, the necessary condensing temperature for a certain temperature difference is not the same for the two condensers. Condenser part I has the lowest heat transfer rates in the area with superheated gas, and it is precisely here that the largest effect of increasing the temperature difference is to be seen. For certain condensing temperatures above the starting point (73°C and equal temperature difference of 1.2 K), the ratio between the pinch point temperature differences in the two condenser parts is approximately a factor two. For clarity, a curve where the temperature difference in the two pinch points varied equally is also shown (indicated by the line " $T_{c_II_DT}=T_{c_I_DT}$ ").

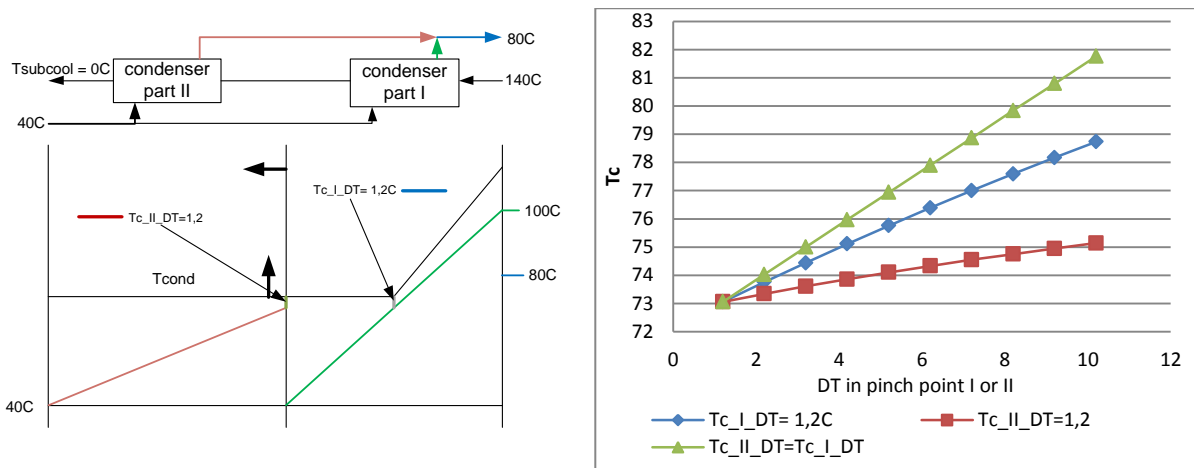

Figure 7: Influence of different pinch point temperature differences on the condensing temperature

Figure 8 shows how the capacity is divided between condenser part I and part II as a function of the temperature difference in the two heat exchangers. The curve indicated by " $Q_I_T_{c_I_DT}=1,2C$ " shows that the capacity of the condenser part I increases with a rising temperature difference in condenser part II, when the condenser part I has a fixed temperature difference of 1.2K at the same time. In this situation, the opposite effect of decreasing capacity is clear for condenser part II. Independent of the chosen tempera-

ture difference, shown on the x-axis, the sum of the effects in the respective condenser parts is constant.

Figure 9 shows how the quality of ammonia in between condenser part I and part II varies as a result of the variation in the temperature difference in the two heat exchangers.

Depending on which temperature differences are maintained in each of the two condenser parts, the capacity is either increased or decreased in the two parts. Similarly, the ammonia quality in between the two parts will change. This becomes clear in Figure 8 and 9.

The figures are based on calculations, where the heat exchanger area varies. The curves look slightly different when the area is fixed in the two condenser parts.

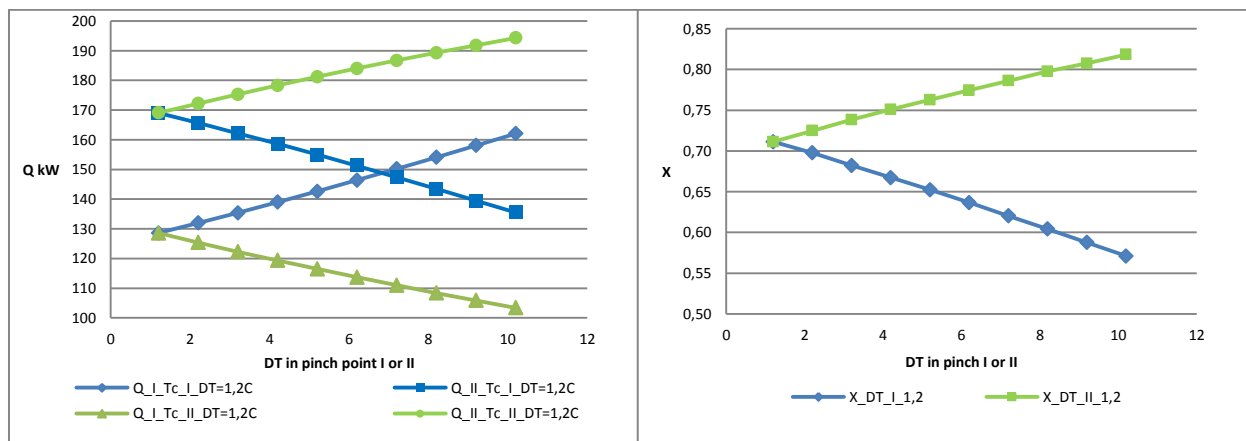

Figure 8: Capacity in part I and part II

Figure 9: Quality of ammonia in between part I and part II

It is important to point out that the temperature out of condenser part II will vary. As mentioned earlier, the temperature out of condenser part I is kept constant at 100°C and the resulting temperature after mixing the two water flows from condenser part I and part II is fixed at 80°C. The variation of the temperature out of condenser part II is shown in Figure 10 as a function of the temperature difference in either condensers; part I or part II.

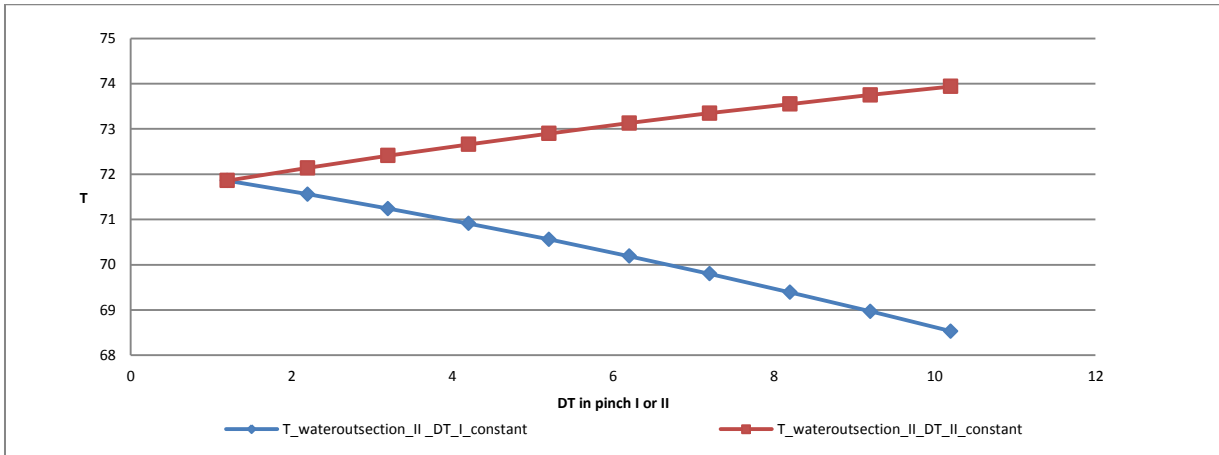

Figure 10: Water temperature out of condenser part I and part II

Taking this knowledge regarding the different temperature differences in the pinch points into account, two calculations of the necessary total heat exchanger area have been made. These calculations are based on a constant temperature difference of 1.2K in condenser part II and two different temperature differences of 3.2K and 7.2K in condenser part I. The results are shown in Figure 11 together with the results shown previously in Figure 5 and 6. Now, it becomes clear that the heat exchanger area and the heat exchanger cost (number of plates) for a fixed condensing temperature can be reduced. Alternatively, the condensing temperature can be reduced and the efficiency of the heat pump for the same heat exchanger area can be improved.

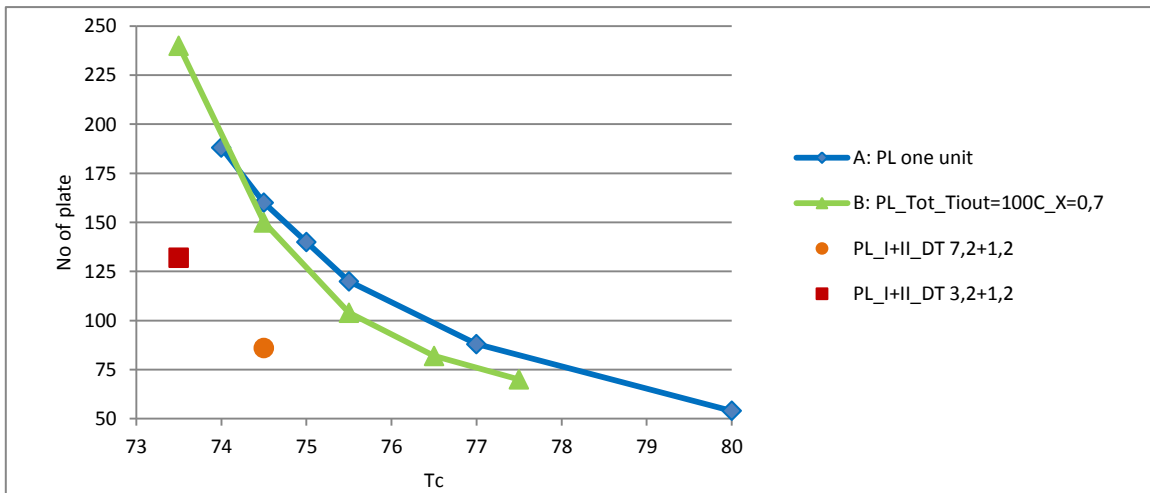

Figure 11: Heat exchanger area (number of plates) for two different temperature differences in the pinch points

The expected performance of the test heat pump is shown in Figure 12. The graph to the left shows the capacities of the evaporator (Q_0), the condenser (Q_c) and the compressor (W) with and without a sub cooler (sub) for different condensing temperatures. The graph to the right shows the corresponding COP for the heat pump (heating capacity divided by absorbed consumption) without taking the efficiency of the drive line (electric motor and frequency converter) into account.

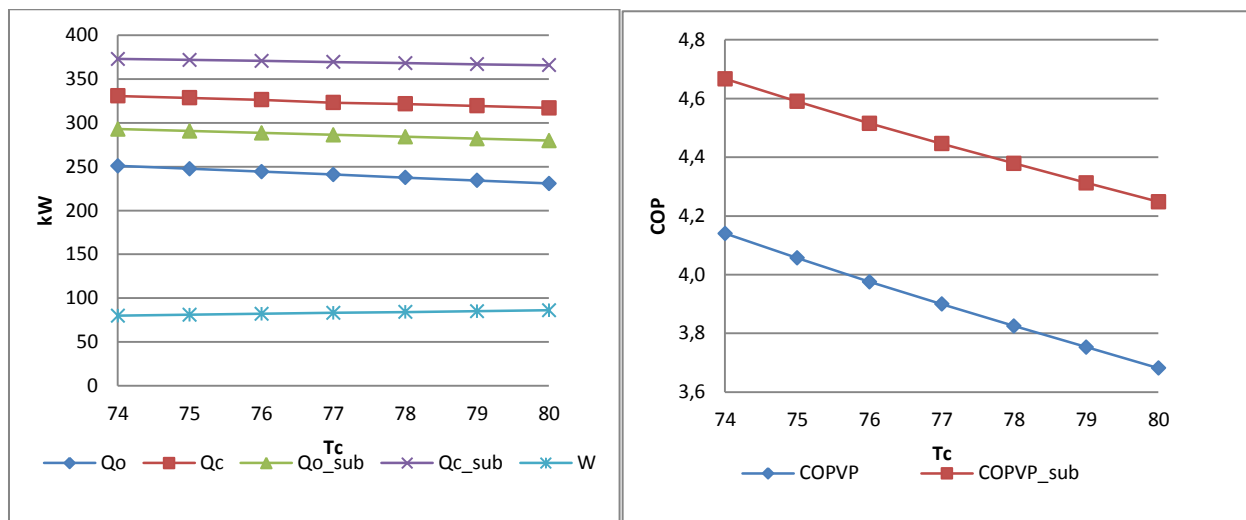

Figure 12: Capacities and expected efficiency (COP) of the heat pump

3.4. Influence of Compressor Type

Heat recovery from the compressor depends on the used type of compressor. When comparing between reciprocating compressors and screw compressors, one has a choice between different ways of connecting the water circuit. As the oil temperature out of a screw compressor is higher than that of a comparable piston compressor, one could, under the right conditions and the assumption that the isentropic efficiency is equal, achieve a higher COP if choosing a screw compressor. Typically, the oil and head cooling of a reciprocating compressor is done with relatively low water temperatures (up to between 40°C and 50°C). Thus, the heat recovery from oil and head cooling can typically only be used to pre-heat the sink water. Screw compressors used on heat pumps can normally run with relatively high oil temperatures into the compressor (typically close to the condensing temperature). Since the oil temperature out of the compressor is equal to the discharge gas temperature, the oil heat recovery in the oil cooler can normally cover the whole temperature lift on the heat sink.

For normal operating applications, the reciprocating compressors tend to have a slightly higher isentropic efficiency than corresponding screw compressors. However, other factors come into play when choosing the right compressor for the application.

4. Simulation with EES and CAS 2000

In the project, an EES calculation tool was developed to examine the possibility of reducing the condensing temperature, when the condenser alternatively was split into two parts.

Figure 13 illustrates the interface of the calculation program in the EES program.

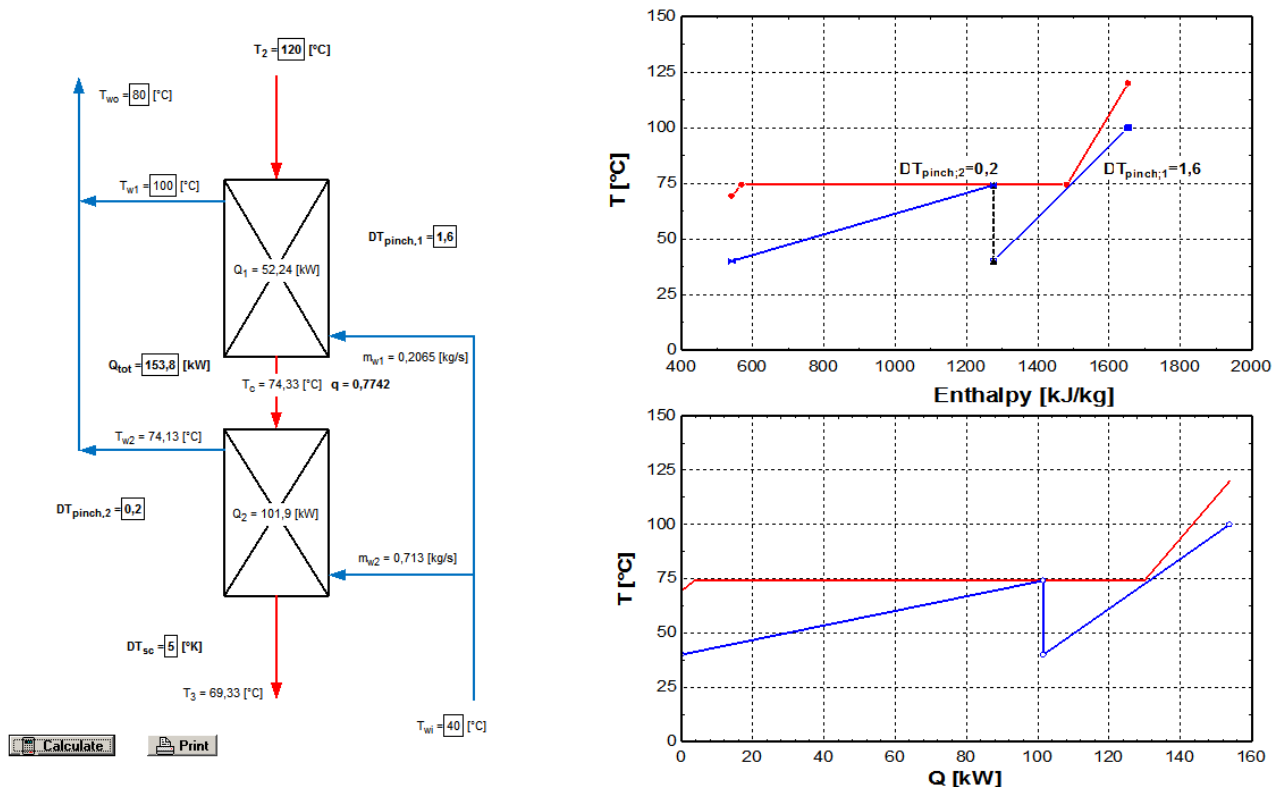

Figure 13: Calculation model (EES) for split condenser system

The program calculates the condensing temperature based on a total mass flow of water and the distribution of this between the two parts as well as the given discharge gas temperature and sub-cooling. Moreover, the calculation is based on the total in and out temperature of the water conditional on a given temperature difference in the two condenser parts' pinch points.

The method does not include the area of the heat plate exchangers when determining the condensing temperature. The analysis is entirely based on energy balances. The reason for this is that, initially, the purpose was to find the distribution of water with the least condensing pressure. The analysis showed that a variation was practically non-existing, but the calculation program was, however, extensively used in combination with Alfa Laval's calculation program CAS 2000 to determine necessary areas.

Much time was spent on making the Alfa Laval calculation program optimize the split of the heat exchangers and on making the software work with a model of the heat pump in the EES program. However, this work was not completed as the routines for calculating this optimization became too comprehensive and time consuming.

Therefore, the calculations for optimizing the condensing temperature and the area were solely based on the temperatures 40°C in and 80°C out on the warm side and 30°C in and 25°C out on the cold side. The calculations were time consuming, but as the analysis in chapter 2 indicates, the splitting of the condenser can lead to a reduction in the total area.

5. Description of Liquid Separator / U-Turn (Alfa Laval)

Some of the most common problems and solutions for evaporators installed in ammonia refrigeration systems have been considered in the development of a dedicated separator vessel design for Alfa Laval's semi-welded plate heat exchangers, called U-turn. The main driver for the inventors, Sollie and Strömblad, has been the development of a very compact flooded system with increased efficiency by enabling higher evaporation temperatures and at the same time reducing the refrigerant charge to a minimum as well as ensuring correct operating condition by synchronizing pressure drops in the evaporator and the liquid head. One of the lessons learned from troubleshooting, and an important reason for reduced performance, is the fact that many contractors and system builders seem to apply some safety margin in their designs in terms of increasing the liquid head applied to the evaporator. The result is an increased circulation rate and a higher pressure drop in the wet return line and hence reduced performance through lower compressor suction pressure. In order to compensate for the increased wet return line pressure drop, i.e. to achieve the same pressure in the separator, it is necessary to operate at a higher evaporation temperature. The need for adjusted evaporation temperature in the heat exchanger is rarely communicated or accounted for in the thermal specifications, even if it is a fairly simple task to do so. A correctly specified heat exchanger evaporation temperature is becoming increasingly important for the heat exchanger design as the approach temperature gets closer.

5.1. U-Turn and Evaporator

The thermosiphon system is a natural circulating system driven by the density difference in the evaporator, the wet return line and the drop leg, often referred to as liquid or driving head. The evaporator drives the refrigerant circulation by evaporating liquid into vapor and, thus, changing the density in the evaporator and the wet return line. The circulation of refrigerant adjusts itself according to the balance in the system where the liquid head and the pressure drops in piping, components and evaporator are equal, see Figure 14.

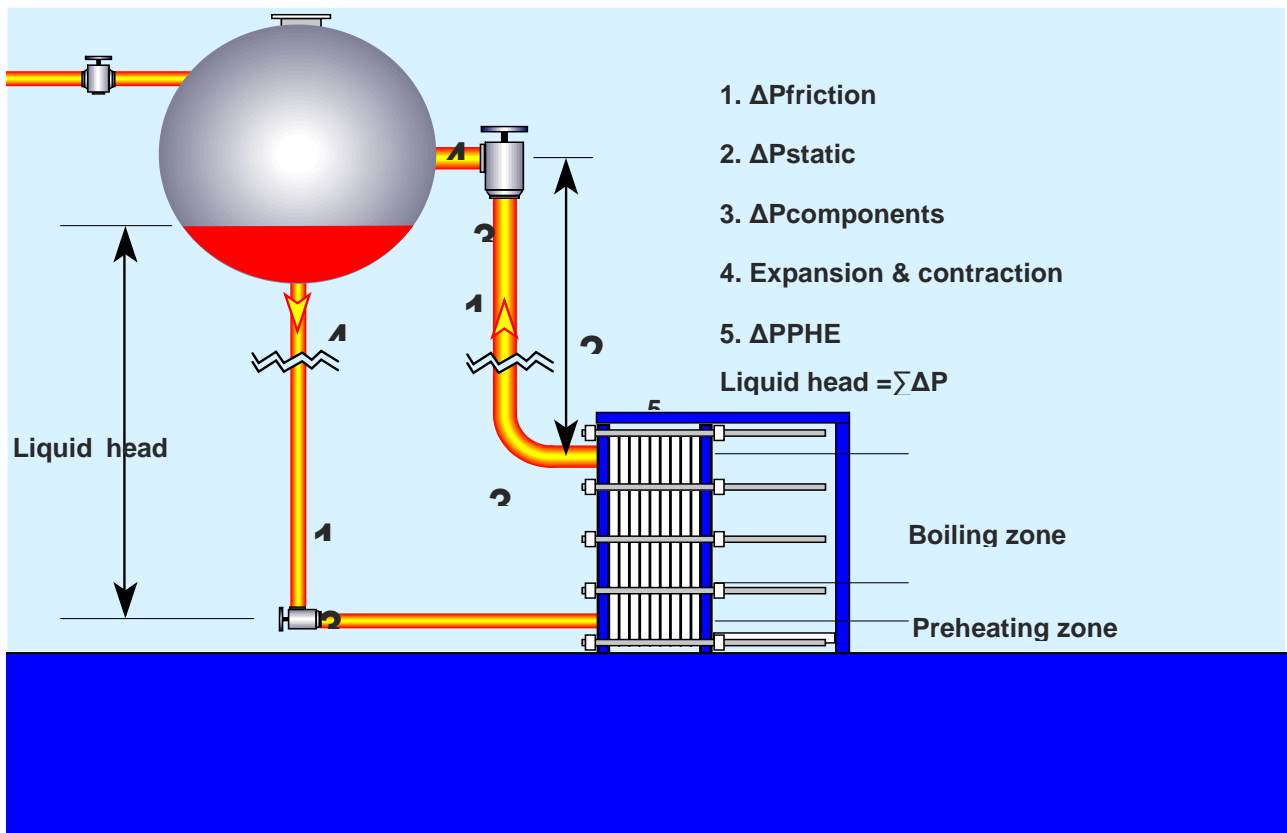

Figure 14: Thermosiphon system and pressure drops from Stenhede (2005)

Setting the balancing pressure at the inlet of the heat exchanger, the following equation can be formulated:

$$rgH - Dp_{dl} = Dp_{PHE} + Dp_{wrl} \quad (1)$$

Where: rgH = liquid head

Dp_{dl} = drop leg pressure drop

Dp_{PHE} = heat exchanger pressure drop

Dp_{wrl} = wet return line pressure drop

Generally, the pressure drop in the drop leg is negligible unless there is a valve or orifice installed to increase the pressure drop in the drop leg in order to obtain specific refrigerant circulation rates and, thus, certain outlet vapor qualities from the evaporator. Equation (1) clearly shows that the pressure drop on the evaporator side is constant and, thus, only distributed between the evaporator and the wet return line in connection with systems where the liquid level is held constant.

When applying a large liquid head to an evaporator with a small pressure drop, the pressure drop in the wet return line will automatically increase by running at higher liquid fractions, i.e. increasing circulation rates. Consequently, evaporator charge has to be increased. However, the consequence for the evaporator with a higher pressure drop in the wet return line is that the evaporation temperature and pressure are reduced, which affects the efficiency. To compensate for the wet return line pressure drop, either a lower liquid head can be chosen or a higher evaporation pressure/temperature is necessary. The latter solution will require a larger heat exchanger surface area, i.e. more plates. Adding plates also mean lowering the pressure drop in the heat exchanger due to lower channel mass flows as well as increasing the refrigerant charge. Hence, pressure drop in the wet return line increases and further compensation in the heat transfer area is needed.

Figure 15 shows how much the evaporation temperature is increased by a wet return line pressure drop equal to a one meter liquid column at different evaporation temperatures.

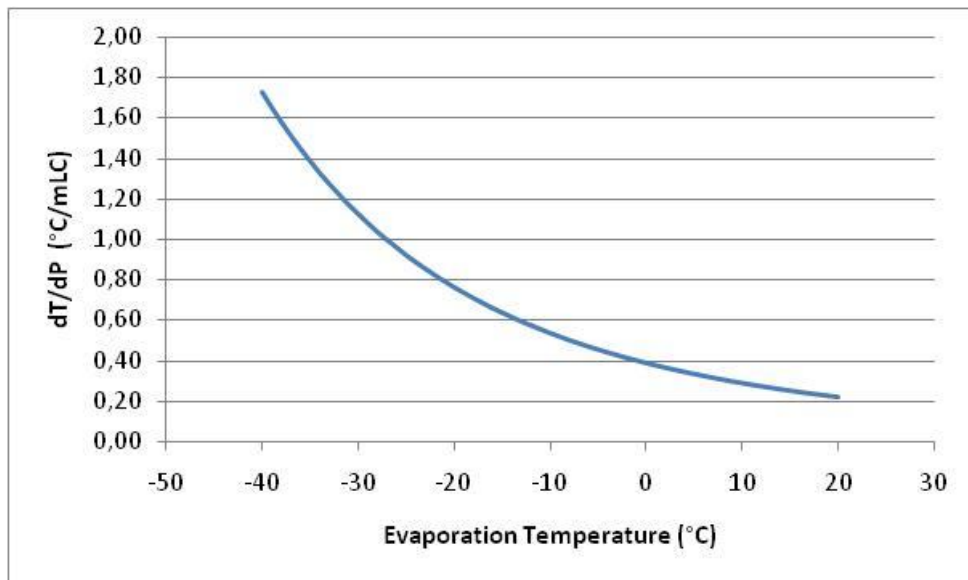

Figure 15: dT/dP at various evaporation temperatures

To compensate high pressure drops in the wet return line is of course more critical for duties where a close approach is required, as the available increase in pressure is limited by the temperature difference between the outlet brine and the evaporation temperature, i.e. the approach temperature. Figure 15 clearly shows that the wet return pressure drop is important for the design of the heat exchanger, especially at low evaporation temperatures.

5.2. U-Turn Separator Vessel

A traditional separator vessel for evaporators generally consists of a short vessel with a fairly large diameter. The large diameter is chosen in order to have low velocities in the separator and hence a short separator length. On the other hand, the U-turn separator has a smaller diameter, and consequently, it needs a longer length to obtain the same separation efficiency. The vessel is made of standard sized stainless steel pipes and it bends and forms as a "U" on top of the evaporator, see Figure 16.

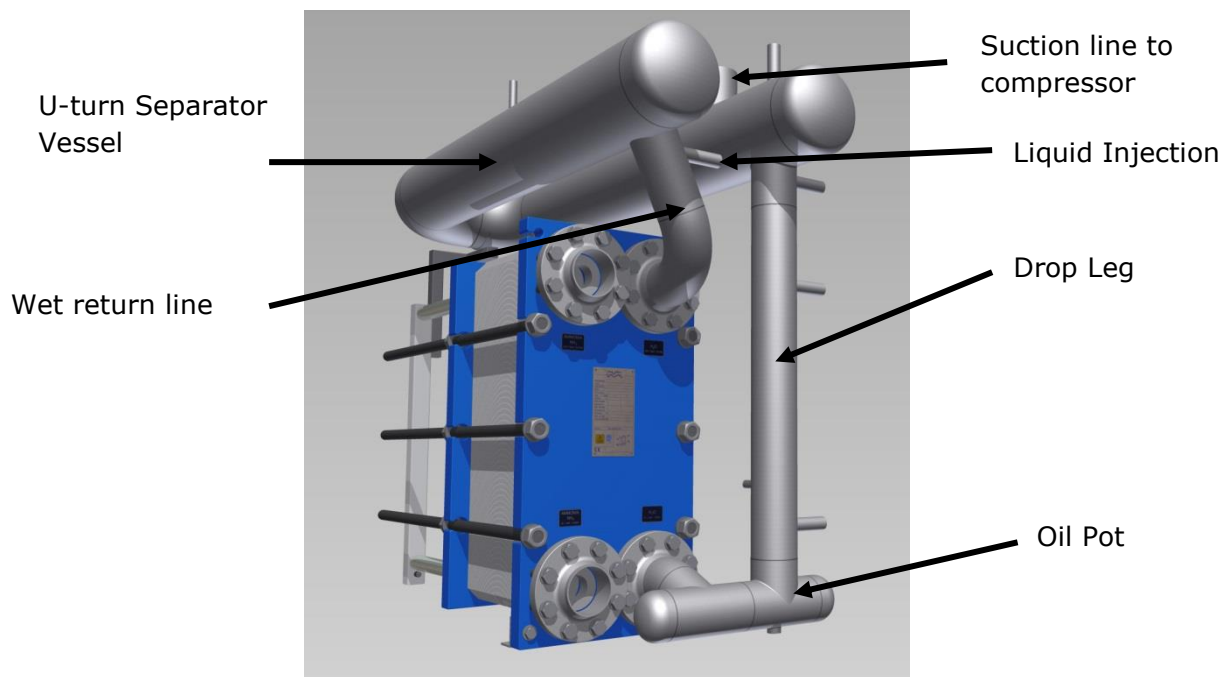

Figure 16: U-turn separator

The outlet of the evaporator connects to the separator by the wet return line with a short length, a single bend, and one expansion into the vessel to minimize pressure drop. The liquid is separated from the vapor in the vessel by agglomeration, gravity, centrifugal forces, and surface tension. The separated liquid is returned to the front of the evaporator.

With this setup's level control in the drop leg, a liquid receiver is installed to handle load fluctuations, see Figure 17.

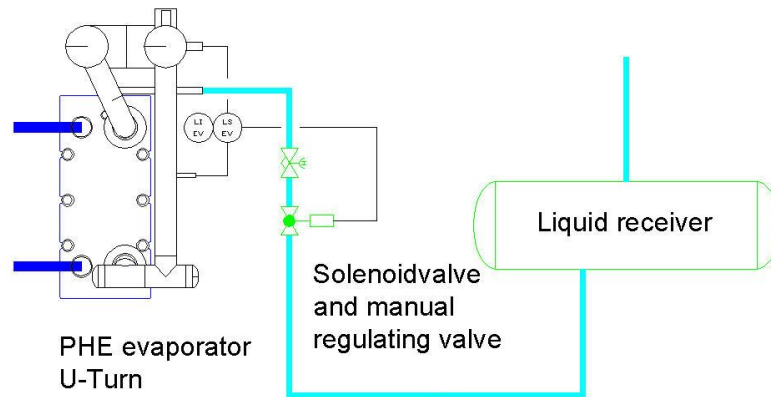

Figure 17: U-turn separator vessel with liquid level control

In the setup, a pump between the U-turn and the evaporator have been integrated, because of the temperature program and the chosen type of plate. The picture in Figure 18 shows the low pressure side before it was connected to the rest of the system.

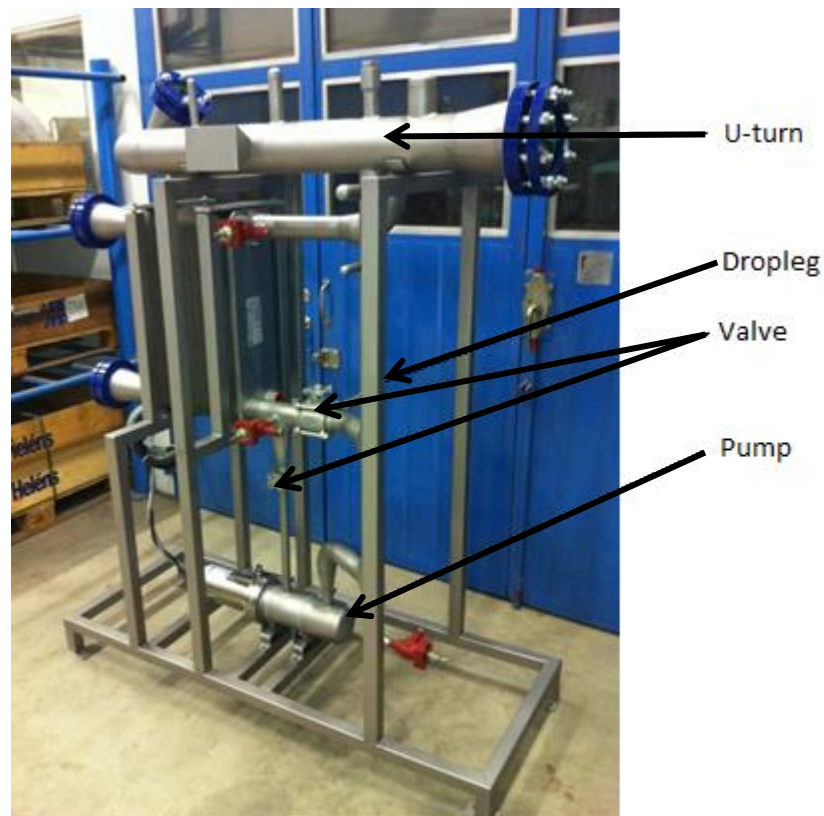

Figure 18: Evaporator section with U-turn and liquid pump

The size of the heat exchanger depends on several parameters. When ignoring the media, the temperature profiles on both sides and the allowable pressure drop play a significant role in determining how large the necessary area needs to be.

Whether or not it is worthwhile to integrate a pump on the refrigerant side of the evaporator depend on previously mentioned parameters. If the temperature drop on the water

side of the evaporator is large, and if the pressure drop on the refrigerant side is unlimited, then the necessary area could be reduced significantly. This simply requires that a pump is integrated.

Which temperature drop that needed to be advantageous in order to integrate a pump depends very much on the evaporator type. Different types of heat exchangers will generate different pressure drops depending on how they are designed/constructed. In addition, each type of heat exchanger can be designed with more than one type of channel.

It is possible to choose a large frame with few channels or a small frame with a large number of channels. Typically, there are three channel types to choose from, and the temperature and the allowable pressure drop determine which one that fits.

In some cases, the pressure will be limited on the water side. However, in connection with relatively large temperature drops on this side, the limited pressure will typically be on the ammonia side.

The way in which the pump is connected is a result of the fact that the pump is not optimized for this duty. Moreover, the pump is much too large to fit the capacity of the installed evaporator. Therefore, a valve has been installed to take up most of the pressure generated by the pump.

In this setup, it is possible to run the system as flooded or as pump feed. Furthermore, it is possible to run up to about 70% of the evaporator capacity in flooded mode. Above this level, it is required that the pump is turned on. This is automatically controlled.

Above 70% of the evaporator capacity, the pump is linked directly to the compressor capacity and below 70%, the liquid level is adapted to the compressor capacity in the same way.

It has not been possible to test all the functions mentioned here because the volume of ammonia was low at the low pressure, which resulted in a very fast reacting system. Moreover, the ammonia level in the drop leg became unstable when changing to pump mode. The only way to run the system with the pump was to increase the level of ammonia so that it was inside the U-turn, which it is not designed for. Chapter 7 provides further details on the test results.

5.3. Optimum Circulation Rate

Two phase flow and heat transfer in tubular heat exchangers are complex subjects which involve many different flow patterns and heat transfer mechanisms. For plate heat exchangers, the complexity is even greater due to the three dimensional structure of the corrugated plate channel. However, the basic principles are the same and can be described with similar models as for tubular heat exchangers. The flow patterns for vertical and horizontal tubes are shown in Figure 19 and 20.

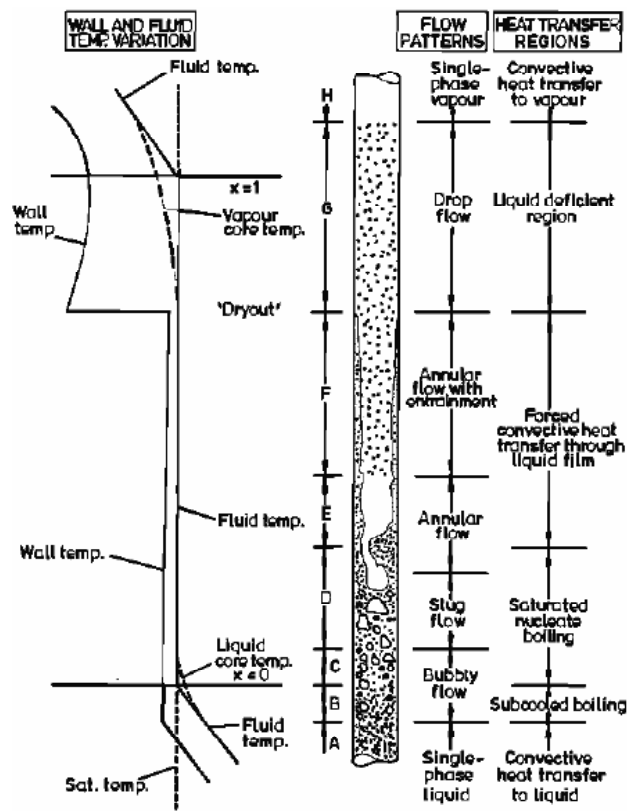

Figure 19: Heat transfer regions in convective boiling in a vertical tube from Collier and Thome (1994)

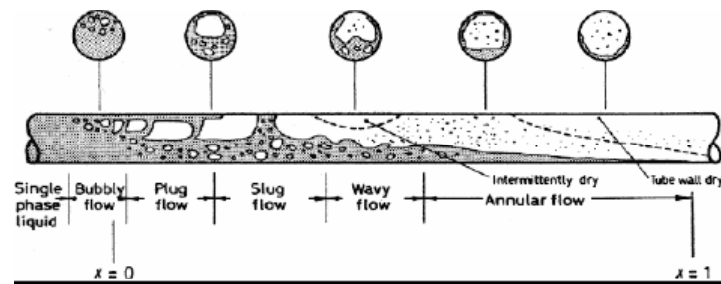

Figure 20: Flow patterns during evaporation in a horizontal tube from Collier and Thome (1994)

Without going into details about modeling of evaporation in vertical and horizontal tubes, graphs of such simulations can be used to describe the behavior that determines optimum circulation rates for flooded evaporation in plate heat exchangers.

First of all, it may be noted that flow patterns in plate heat exchangers to some extent can be regarded as a mixture between horizontal and vertical tubes as the channels consist of half-tubes with low and high angles, similar to inclined tubes. However, the complexity in plate heat exchangers is greater in that the two halves that make up the channel interact with each other. Nevertheless, the basic heat transfer principles are similar and here the focus is on local heat transfer coefficients, in particular the liquid deficient or dry-out region. Figure 21 shows flow patterns and local heat transfer coefficients as function of vapor quality for evaporation in a horizontal tube.

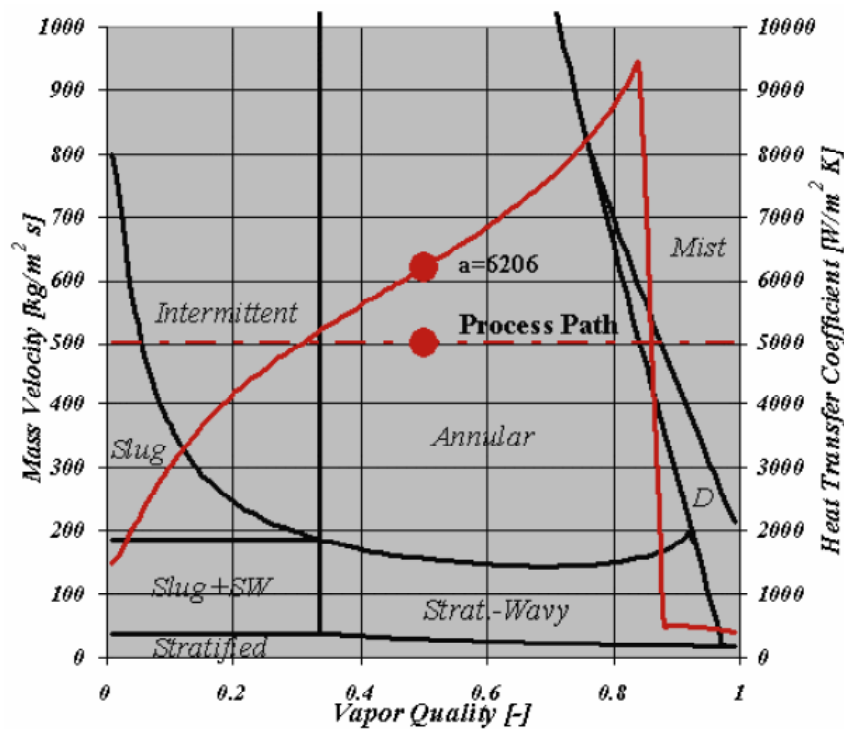

Figure 21: Simulation of Wojtan-Ursenbacher-Thome flow boiling model for R134a at a mass velocity of 500 kg/m²s and a tube of 10 mm internal diameter

The red line represents the local heat transfer coefficient and the dotted red line represents the process, i.e. evaporating saturated liquid to saturated gas ($x = 0$ to 1). The black lines show the boundaries between the different flow patterns.

The figure clearly shows that the heat transfer coefficient (red line) drops dramatically once it enters the mist region. Here, the heat transfer changes from evaporation to single phase heat transfer with gas. The drop in heat transfer coefficient may be as high as a factor 10 to 100. In order to avoid this drop in heat transfer, it is essential that all surfaces are properly wetted to have optimum heat transfer and hence, the highest evaporation temperature possible. Considering that the recirculation rate is the inverse of the outlet vapor quality, $CR = 1/ X_{out}$, Figure 21 indicates that the optimum circulation rate should be higher than $1/ 0.83 = 1.2$. In practice, the optimum circulation rate for plate heat exchangers evaporating ammonia is normally in the range of 1.25 to 1.4.

6. Description of Laboratory Test Unit

The ammonia (NH_3) system and the liquid (water) system of the purpose built heat pump unit are described in this chapter. The unit is connected to the brine system of the laboratory to remove excess heat. Figure 22 shows the basic P&I diagram of the test unit.

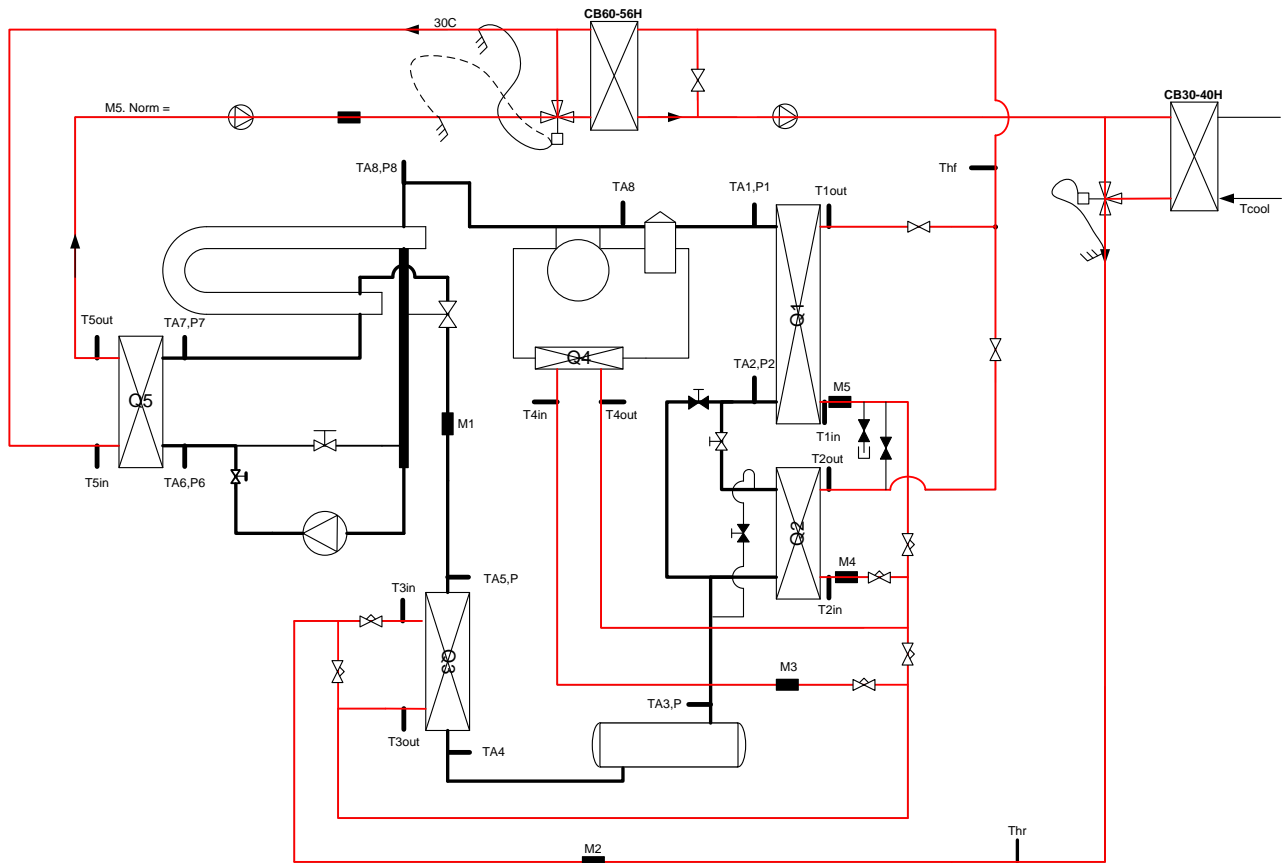

Figure 22: Basic P&I diagram of the test heat pump

A detailed version of the P&I diagram is found in Appendix A.

6.1. Ammonia System

Central to the ammonia system is the six cylinder high pressure reciprocating compressor, Mycom N6HK. The compressor can be adapted to the actual need for capacity by a combination of engaging and disengaging cylinder pairs and by adjusting the motor speed by means of a variable speed drive.

Together with the high efficiency oil separator, U-turn suction separator and heat exchangers, the compressor forms the main components of the ammonia system.

Two principles of operation are possible: Thermosiphon (natural circulation) and pump circulation. In both principles, the level in the downpipe connected to the inlet of the evaporator and the ammonia pump is controlled by a level sensor rod in combination with an electrically operated expansion control valve.

The pump used for this purpose is a Grundfos RC2-7/4 refrigerant pump. The pump characteristic is found in Appendix C.



6.2. Liquid System

The liquid (water) system comprises of a cold and a warm circuit. The cold liquid is pumped through the evaporator (Q5) and provides the energy source for the heat pump. The warm liquid is pumped through the condensers (Q1 & Q2). The sub-cooler (Q3) and the oil cooler (Q4) are the energy recipient for the heat pump.

To make the liquid system energy effective for test purposes, the cold and warm circuits are connected through an intermediate heat exchanger. The heat exchanger makes it possible to reuse the energy from the warm circuit in the cold circuit.

The only energy that has to be disposed of to the external cooling tower is the energy supplied to the compressor motor.

To establish versatile test conditions, especially the warm circuit has been equipped with separate flow sensors (M3 to M5) for each heat exchanger together with temperature sensors (T1 to T4) at in- and outlet. This setup makes it possible to map the energy exchange in the heat exchangers individually.

When using the ammonia mass flow, measured with flow sensor (M1A), it is possible to run a comparison of the energy exchange between the liquid side and the ammonia side.

A number of control valves in the warm circuit make it possible to change the amount of liquid flow to the heat exchangers and the condensers (Q1 and Q2) can be operated with a serial liquid flow or a parallel liquid flow.

For the purpose of maintaining a constant temperature of the liquid at the inlet of the evaporator (Q5) and the condensers (Q1 & Q2), the two 3-way mixing valves are built in, one in each circuit. The 3-way mixing valves are controlled by two PID-controllers with temperature sensors (T) located in the liquid inlet of the evaporator (Q5) and the condensers (Q1 & Q2).

It is possible to change the location of the temperature sensor from the evaporator inlet to the evaporator outlet in case a constant temperature from the evaporator is desired.

Warm circuit 3-way valve

Cold circuit 3-way valve

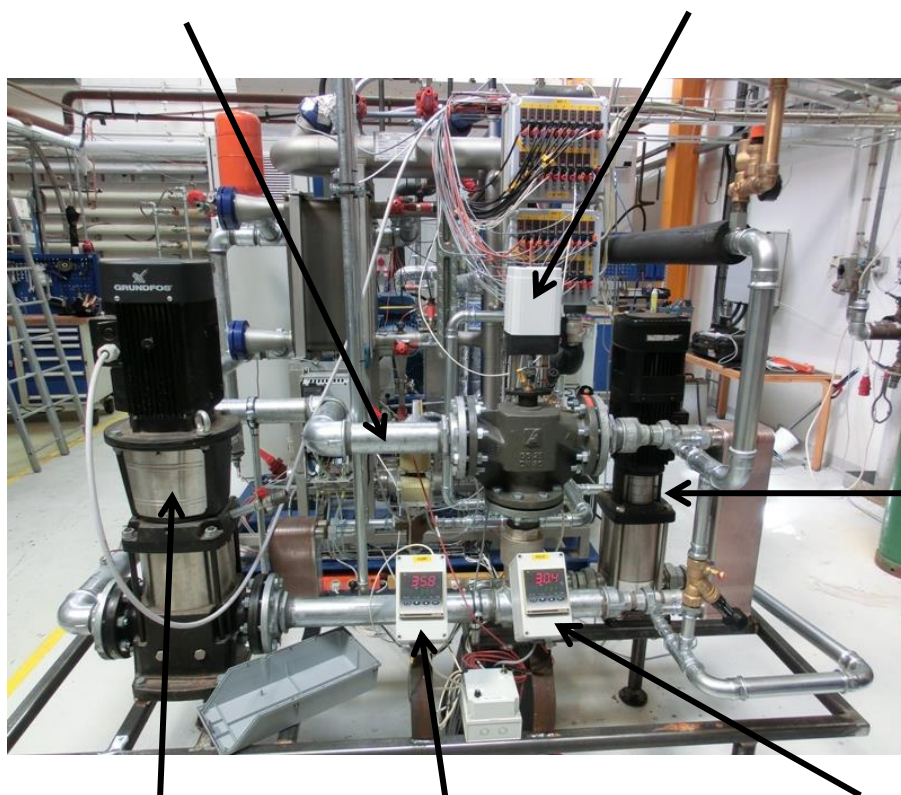

Warm circuit pump

Cold circuit pump

Cold circuit PID-controller

Warm circuit PID-controller

The 3-way valves and the pumps are by sight very different in size due to the fact that the temperatures and the amount of liquid flow are very different in the two circuits.

- Cold circuit: 50 m³/h @ 30°C to 25°C
- Warm circuit: 7.7 m³/h @ 40°C to 80°C

6.3. Main Components

The main components are shown in the following pictures.

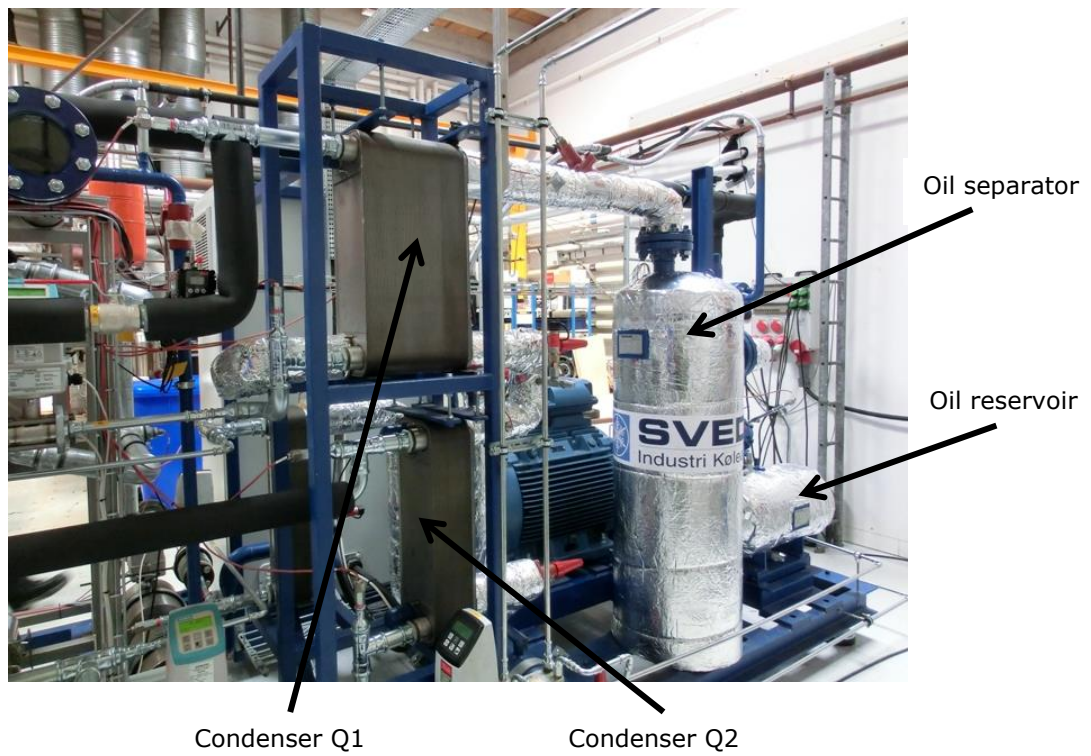



Control
switchboard
& frequency
converter

Oil cooler Q4

Compressor

Electric motor



NH₃ sub-cooler Q3

6.4. Control System

The control system is based on Siemens PLC and it controls the main components on the heat pump, e.g. motor, compressor, liquid pump, expansion valve and a few other components. The control system also functions as a surveillance system with alarm limits for various measured parameters, mainly temperatures and pressures.

The motor is controlled by a frequency converter, which is integrated into the control panel. The speed can be varied between 900 and 1500rpm (limits are set by the compressor manufacturer).

The compressor capacity can be controlled by enabling or disabling a pair of valves. This is controlled by solenoid valves on the compressor block.

The total capacity of the compressor is a combination of speed and a number of cylinders. The control system has two types of regulation: step and linear regulation.

With step regulation, the compressor starts at low speed with two cylinders loaded. The capacity will then be increased, first by switching on the second and the third pair of valves (while still running at minimum speed). When all cylinders are active, the speed will be increased. This type of regulation provides a step wise regulation in the lower capacity range (from 20 to 60% total capacity) and a continuous regulation in the upper capacity range.

The linear regulation combines speed and cylinder regulation in the complete capacity range. First, the capacity is increased by speed until the maximum speed is reached. Then the next pair of cylinders is activated, while at the same time the speed is reduced to keep the same total capacity. The linear regulation differs from the step regulation in the lower capacity range (from 20 to 60% total capacity) in that the linear regulation provides a nearly continuous regulation all the way from the minimum capacity.

The oil return from the oil separator is controlled by a level switch and a solenoid valve.

The expansion valve opening is controlled with a PID regulation based on the level in the drop leg of the evaporator.

The pump speed can be controlled by either the differential pressure over the pump or the capacity of the compressor.

6.5. COP Calculation

The COP (coefficient of performance) factor is calculated in the heat pump mode by adding the energy transferred to the liquid in the heat exchangers (Q1 to Q4) and dividing with the electrical power supplied to the control switchboard. The power to the motor itself is not measured independently.

In the liquid cooling mode, an EER (Energy Efficiency Ratio) factor can be calculated from energy extracted from the liquid in the heat exchangers (Q5) and divided with the electrical power supplied to the control switchboard and the electric motor.

The same calculations can be made with values from the ammonia side of the unit.

Power to the cold and the warm circuit pumps are not included in the electrical power supplied to the control switchboard and the electric motor.

7. Test Results with Novel Ammonia Heat Pump

7.1. Purpose of the Tests

The ammonia heat pump has been tested under different operating conditions to validate the heat pump performance and to prove the concept of a condenser being split up into two parts.

The tests are mainly to show:

- The effect of pre-heating the water on the sink side with heat from the sub-cooler and the oil & cylinder head cooler
- The effect of varying the distribution of the load (water flow) on the two condensers
- The functionality of the U-turn mounted directly above the evaporator (minimum height) and the use of a pump for forced liquid circulation

7.2. Description of Test Unit

The test unit was equipped with various sensors to measure the temperature, the pressure and the flow. The placement of the sensors is seen in the P&I diagram, see Appendix A. Chapter 6 provides a detailed description of the test unit.

7.3. Functional Tests

After the initial start-up, some minor issues with the newly developed PLC controller needed to be cleared before actual performance testing could be started. Regulation of the liquid level turned out to be rather unstable, but after some trial and error it was possible to find PID regulating parameters for the expansion valve that gave an acceptable control of the liquid level. The regulation of the distribution of the water flow through the different heat exchangers showed up to be very easy and accurate. An accurate regulation was necessary to reach the intended running conditions in a steady way without triggering some of the alarm limits (maximum discharge pressure, maximum discharge gas temperature, maximum pressure difference).

The surveillance system continuously checks that different temperature and pressure limits are not exceeded. Some of these limits, especially those for maximum discharge pressure, maximum pressure difference of the compressor and maximum discharge gas temperature, are rather close to the intended nominal running conditions. This means that the unit operating condition needs to be changed very gently to avoid unintended shutdowns. This behavior is typical for heat pumps where reaching the highest possible temperatures with the given equipment is desired. This can be challenging for the automatic control system to handle smoothly.

Due to different reasons, it has not been possible to run the heat pump at higher capacities than approximately 65–70% (compressor capacity) in the laboratory. One of the reasons for this was the limitation given by the capacity of the warm water circuit pump. Considerable throttling of some of the water regulating valves was necessary to obtain the intended water flows to the different heat exchangers. This caused a considerable

amount of pressure drops which limited the maximum water flow achievable on the warm side. Another limitation was caused by the evaporator system; the evaporator system was designed to run with natural circulation up to approximately 70% compressor capacity and with a pump circulation above that. Operation with pumped liquid circulation required a high liquid level up into the lower part of the U-turn pipe in order for the pump to run stable with sufficient NPSH. The high liquid level inside the U-turn pipe limited the liquid separation capacity, which in its turn limited the overall achievable capacity.

The amount of refrigerant on the unit has been slightly too high as seen by the fact that operation with a relative low level of liquid in the evaporator resulted in the sub cooling of the ammonia already in the second condenser outlet (Q2). This is possible when the liquid level in the receiver vessel gets too high, i.e. the liquid level stands up inside the outlet of condenser (Q2).

The different test conditions were operated with the unit controlled manually, except for the expansion valve regulation. This was done to have as stable and as constant running conditions as possible. The control of the oil return from the oil separator to the compressor was also disabled during tests, since its activation was found to have a relatively large influence on the compressor capacity.

From the different tests, it was found that the evaporating temperature was slightly lower than expected. Analysis of the different test data and the comparison of calculation data from Alfa Laval indicate that there probably has been an issue with an oil film on the plates of the evaporator and on the sub cooler during the test operation.

The maximum temperature of the water out of condenser (Q1) was limited by the maximum water pressure on the warm side. The safety valve was set at 2.5bar corresponding to a boiling temperature of approximately 138°C. For safety reasons, it was avoided to run with water temperatures near or above 120°C.

The measured water temperatures out of condenser (Q2) are slightly above the condensing temperature. There is a minor calibration error with the water temperature sensor.

The liquid level in the evaporator has been varied depending on the capacity to keep more or less the same quality out of the evaporator. Therefore, the tests carried out at a 33,3% compressor capacity are run with a liquid level of 65%, whereas the tests carried out at a 60% compressor capacity are run with the liquid level increased to 75%.

7.4. Performance Tests

The principle configurations that have been tested are:

- Operation with both condensers (Q1 and Q2) coupled in series on the water side, heating water from 40°C to 80°C
- Operation with both condensers (Q1 and Q2) coupled in parallel on the water side, heating water from 40°C to 80°C with the water temperature out of (Q1) at 100°C
- Operation with both condensers (Q1 and Q2) coupled in parallel on the water side, heating water from 40°C to 80°C with varying load distribution (and water outlet

temperatures) for the two condensers

- Operation with both condensers (Q1 and Q2) coupled in series on the water side, heating water from 40°C to 80°C and varying capacities on the sub cooler (Q3) and the oil & cylinder-head cooler (Q4)
- Operation with natural liquid circulation in the evaporator (Q5), water temperatures in/out of the evaporator at 30°C/25°C and varying liquid level in the drop head
- Operation with pumped liquid circulation in the evaporator (Q5) with varying circulation ratios

The tests were mainly performed at two different capacities; at a 33,3% and a 60% compressor capacity. The two capacity levels were achieved by regulating the speed and the number of cylinders, as indicated in Table 1.

Compressor capacity (%)	No. of cylinders (-)	Shaft speed (rpm)	Swept volume (m ³ /h)
33.3	2 (min)	1500 (max)	66.7
60	6 (max)	900 (min)	120.0

Table 1: Compressor capacities

A total number of 48 different running conditions were tested and recorded. The most important results on heat pump performance are achieved from the tests shown in Table 2.

Test id	Capacity	Connection (Q1 & Q2)	Sub cooling (Q3)/ Oil & head cooling (Q4)	Comments
3	33.3%	Serial	Without (Q3 & Q4)	
2d	33.3%	Serial	Included	
4	33.3%	Parallel	Included	100°C out of (Q1)
5	33.3%	Parallel	Included	Varying distribution (Q1 & Q2)
7d	60%	Serial	Included	
7c	60%	Parallel	Included	100°C out of (Q1)
8	60%	Parallel	Included	Varying distribution (Q1 & Q2)
7a-c	60%	Parallel	Included	Varying liquid level in drop leg
6b	~48%	Serial	Included	Pump operation with varying Δp

Table 2: Tests used to analyze heat pump performance

7.5. Results

The measurements showed that it was possible to achieve the rise in water temperature from 40°C to 80°C with condensing temperatures of approximately 73°C–74°C. The average heating COP factor was 3.9 at a 33.3% capacity and 4.2 at a 60% capacity. The COP varies slightly between the different configurations tested. The average condition of the tests at a 60% capacity was calculated with the Mycom compressor calculation software and it showed very fine resemblance with differences between the calculated and measured values between 3 and 5%.

The average error in the heat balance was 5.8kW for the measurements at a 33.3% capacity, corresponding to 4.6%. The average error for the measurements at a 60% capacity was 7.0 kW, corresponding to 3.5%. For practical reasons in the laboratory, the insulation of the unit was not at the normal level for an industrial heat pump. The heat exchangers, the high pressure receiver and much of the piping were not insulated at all. This was intentionally done in order to be able to make thermography photographs of the system. In addition, some of the piping on the water side was not insulated.

All detailed measurement results are listed in Appendix B.

7.5.1. Test 3: 33.3% Capacity, Serial Connection (Q1 & Q2), no (Q3), no (Q4)

A Q-T plot for the temperature and the capacity for operation without any sub cooling of liquid nor any oil and head cooling is shown in Figure 23. The measured COP factor for this configuration is 3.76. The very small temperature approach is probably due to the fact that the condensers were dimensioned for an approach temperature difference of between 1 and 1.5°C at full load.

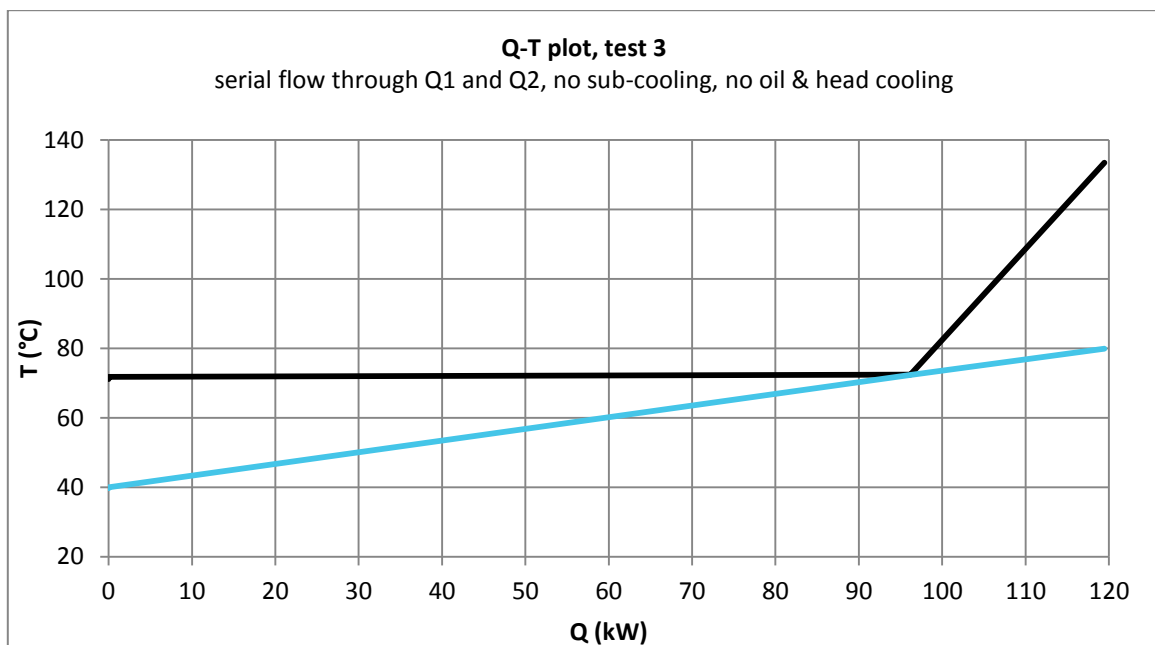

Figure 23: Q-T plot for test 3

7.5.2. Test 2d: 33.3% Capacity, Serial Connection (Q1 & Q2), including (Q3) and (Q4)

When using the oil and head cooling and when the ammonia liquid is sub cooled, then the temperature and the capacity become as shown in Figure 24. The COP factor of this configuration is 4.00, i.e. an improvement of 6.4%. The dotted lines show the temperature rise in the sub cooler and in the oil & head cooler. Due to practical limitation on the water side, the sub cooling of the liquid was limited to approximately 20K.

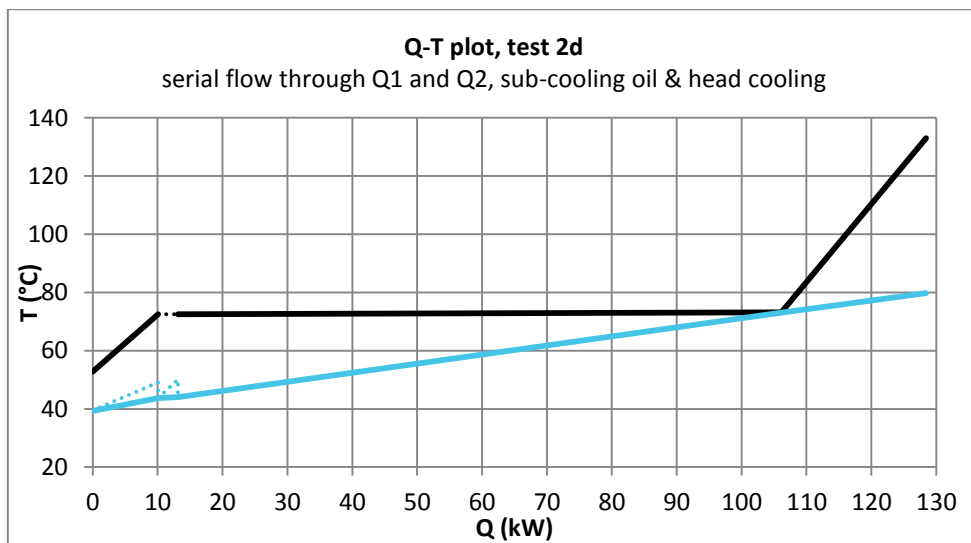

Figure 24: Q-T plot for test 2d

7.5.3. Test 4: 33.3% Capacity, Parallel Connection (Q1 & Q2), including (Q3) and (Q4), 100°C from (Q1)

In this test, the flow through the two condensers is running in parallel. The flow through condenser (Q1) is regulated in order to have a water outlet temperature of 100°C. The capacity and the temperature curves are shown in Figure 25. The pinch point of condenser (Q1) is not measured directly, but it is calculated based on the measured capacities and temperatures. The quality of the ammonia leaving the condenser (Q1) is calculated to be approximately 73% vapor. The COP factor for this test was 3.95, which is nearly the same as for test 2d, as expected.

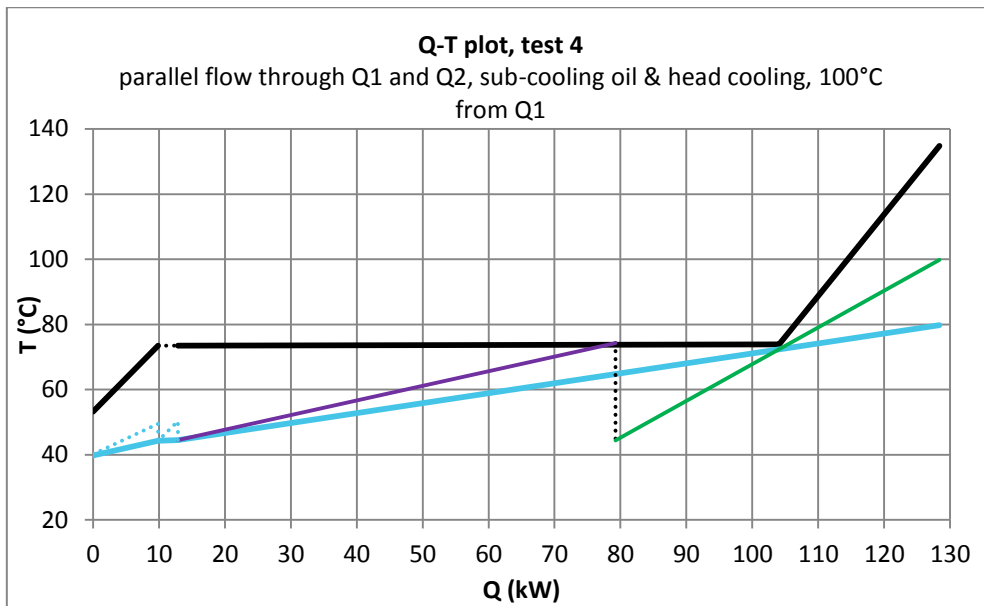

Figure 25: Q-T plot for test 4

7.5.4. Test 5: 33.3% Capacity, Parallel Connection (Q1 & Q2), including (Q3) and (Q4), Varying Distribution between (Q1) and (Q2)

As indicated in Figure 26, the load distribution between the two condensers was varied by regulating the water flow to each condenser. For each test, the total flow was adjusted to maintain a mixed outlet water temperature of 80°C. The distribution between the two condensers was adjusted in ten steps.

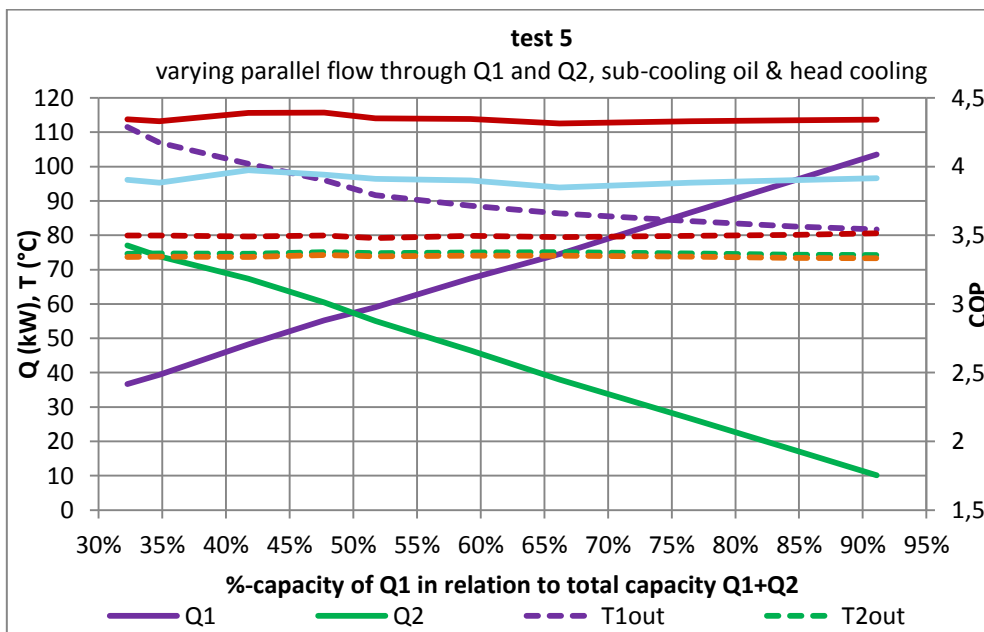

Figure 26: Capacities and temperatures as function of relative load on (Q1)

Figure 27 shows additional results of this test. The position of the different measuring variables is found in the P&I diagram in Appendix A.

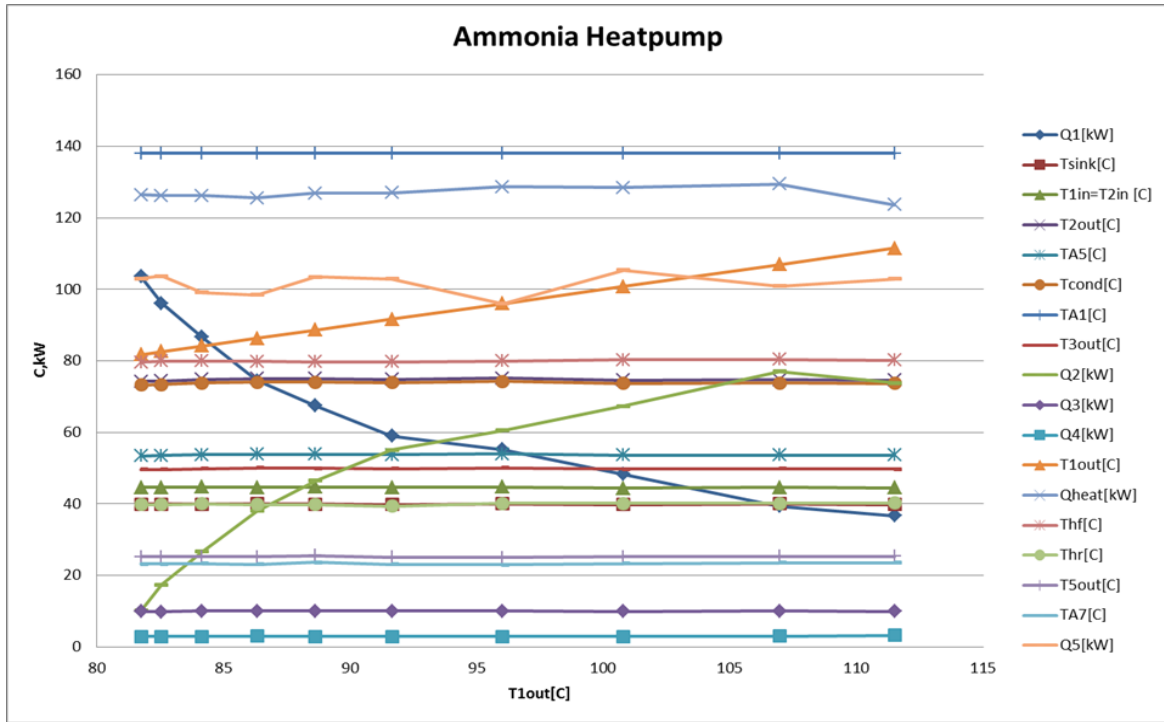

Figure 27: Results of test 5

Figure 26 and 27 make it clear that the outlet temperature for (Q1) increases when the load decreases as a consequence of the lower water flow. Since the total water flow is kept constant, the load on (Q2) increases. The water temperature out of (Q2) remains more or less constant.

7.5.5. Test 7d: 60% Capacity, Serial Connection (Q1 & Q2), including (Q3) and (Q4)

This test is essentially the same as test 2d. The main difference is that the compressor capacity has been raised to 60%. The COP factor of this test was 4.30, which corresponds with an increase of 7.5% compared to the same test at a 33.3% capacity. The performance in test 7d is lower than expected, which is assumed to be related to an oil film in the sub cooler and in the evaporator, see Figure 28.

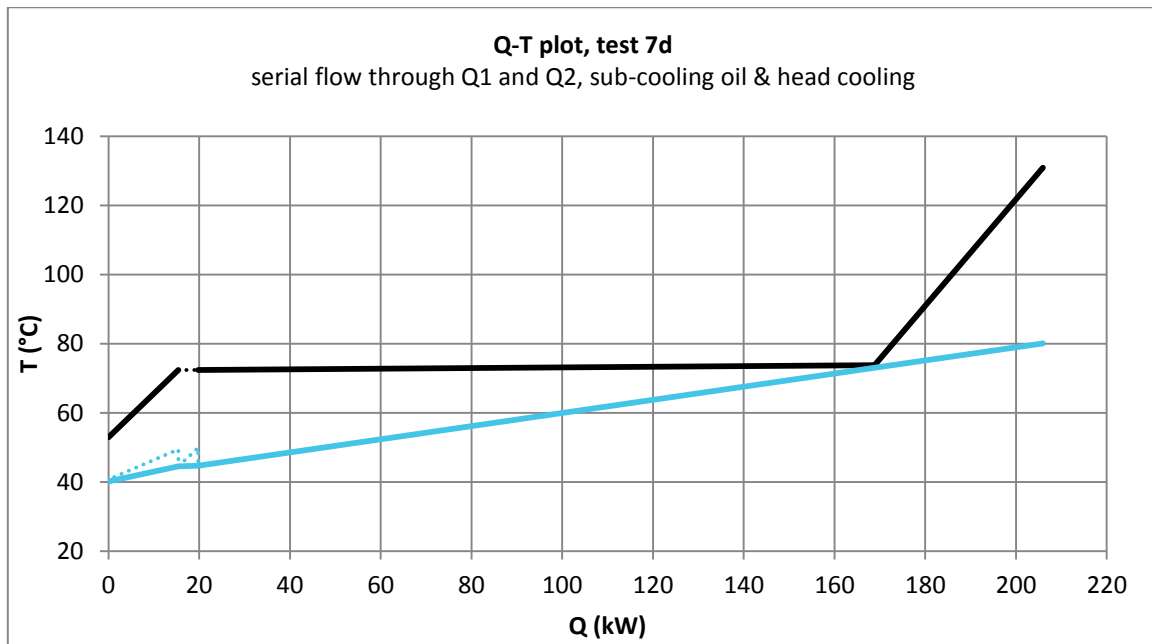

Figure 28: Q-T plot for test 7d

7.5.6. Test 7c: 60% Capacity, Parallel Connection (Q1 & Q2), including (Q3) and (Q4), 100°C from (Q1)

This test is the same as test 4 except for the capacity being at 60%. The COP of this test was 4.22, which is 6.8% above the COP of the same test with a 33.3% capacity. The test shows that the total heating capacity is split up; 24% of the hot water is delivered at 100°C and 76% is delivered at 74°C, see Figure 29.

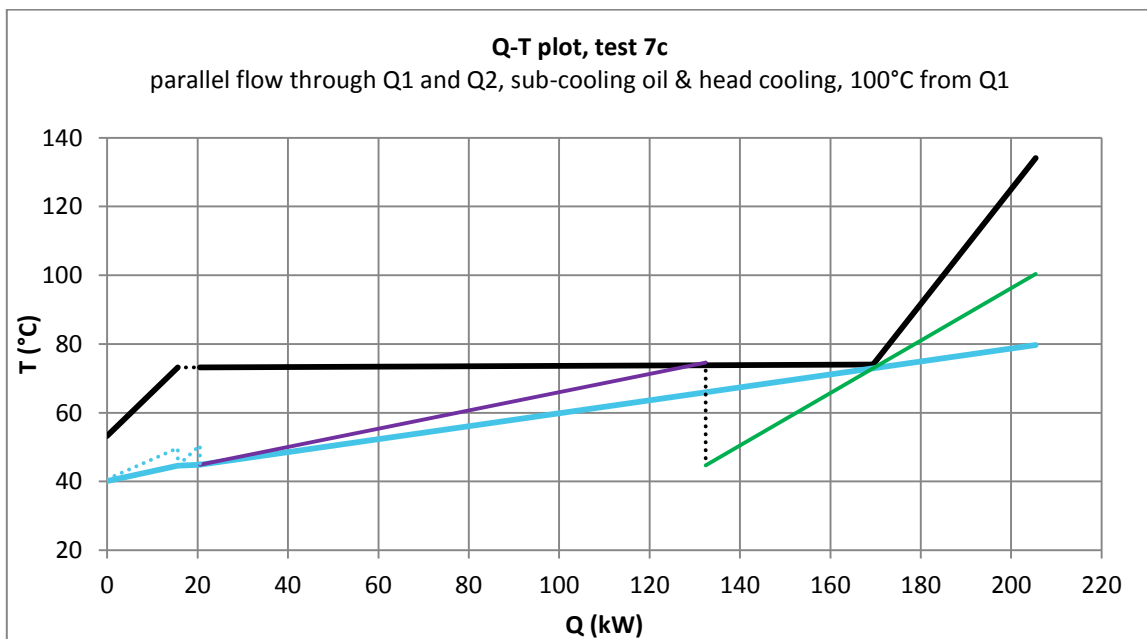

Figure 29: Q-T plot for test 7c

7.5.7. Test 8: 60% Capacity, Parallel Connection (Q1 & Q2), including (Q3) and (Q4), Varying Distribution between (Q1) and (Q2)

The load distribution between the two condensers was varied by regulating the water flow to each condenser. For each test, the total flow was adjusted to maintain a mixed outlet water temperature of 80°C. The distribution between the two condensers was adjusted in nine steps, see Figure 30.

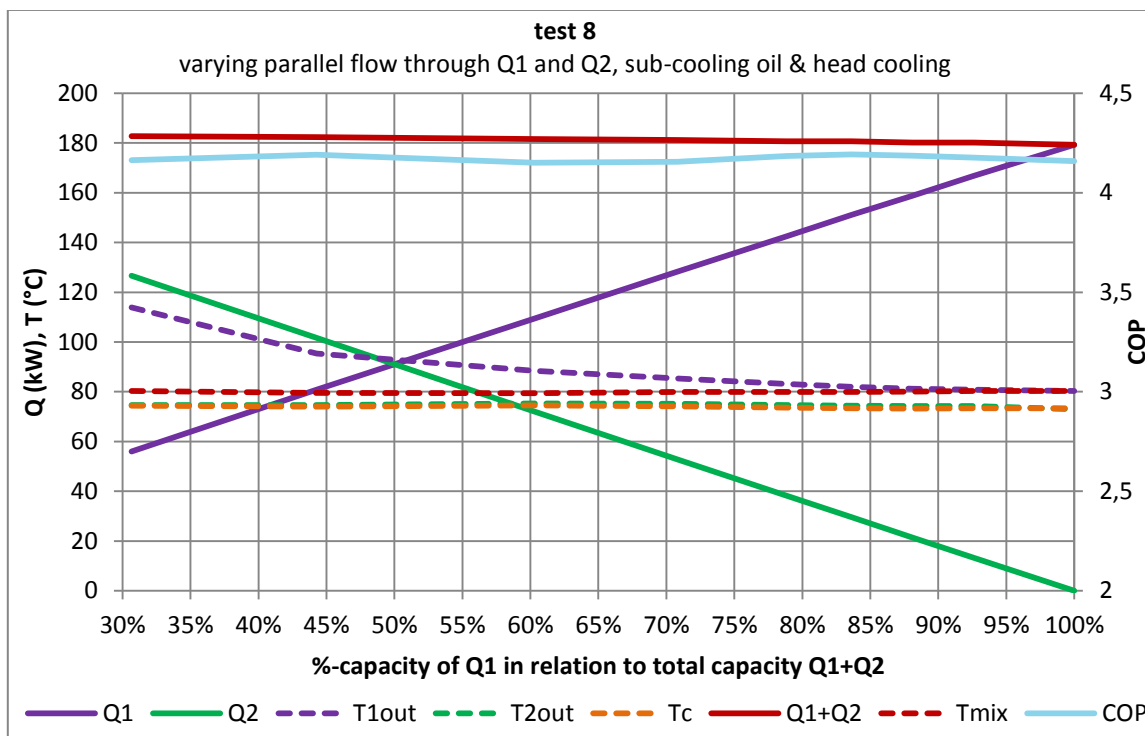

Figure 30: Capacities and temperatures as function of relative load on (Q1), 60% compressor capacity

Figure 31 shows additional results of this test. The position of the different measuring variables is found in the P&I diagram in Appendix A.

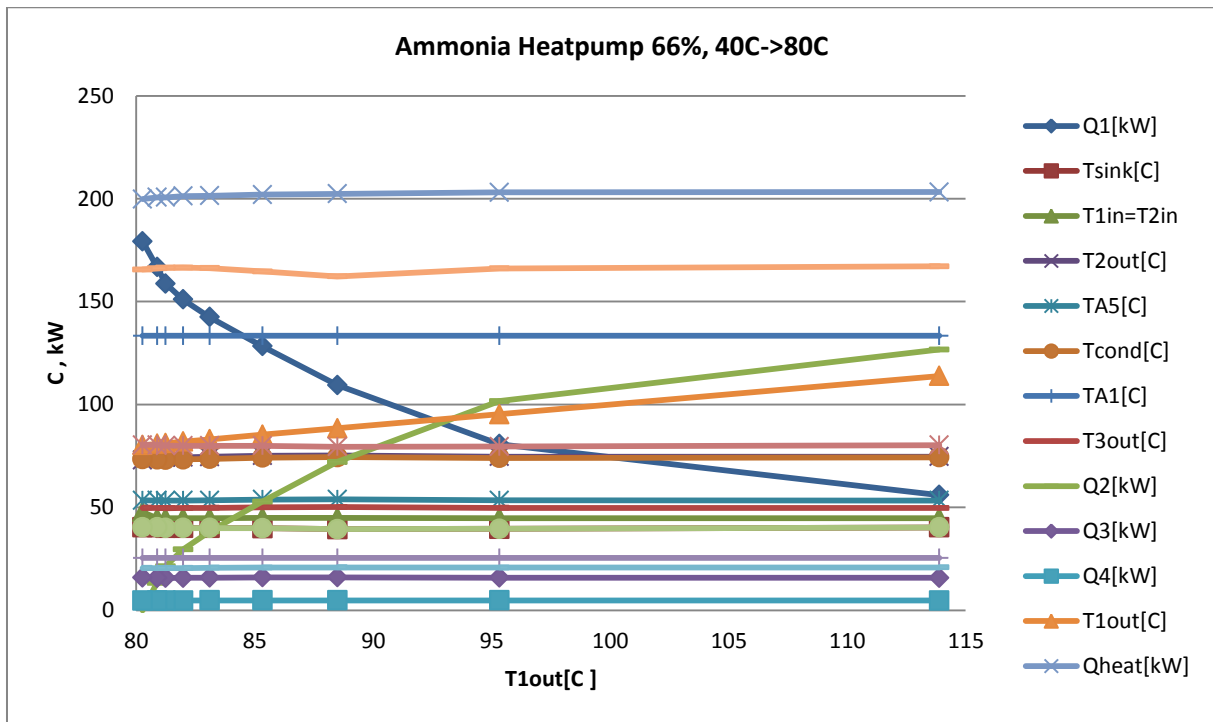

Figure 31: Results of test 8

7.5.8. Test 7a-c: 60% Capacity, Variation of Liquid Level in the Drop Leg of (Q5)

Tests with varying liquid level in the drop leg were carried out as part of the heat pump tests with parallel connected condensers at a 60% capacity. The liquid level in the drop leg was varied in three steps between 65% and 75%. At 65%, the top of the evaporator plates was dry, as can be seen through the sight glass. At 70%, a slight spray of liquid droplets begins to come up from the plates. At 75%, a spray of liquid is established all over the entire width of the evaporator. Figure 32 shows the effect on the evaporator capacity, the evaporating temperature and the COP-factor for cooling.

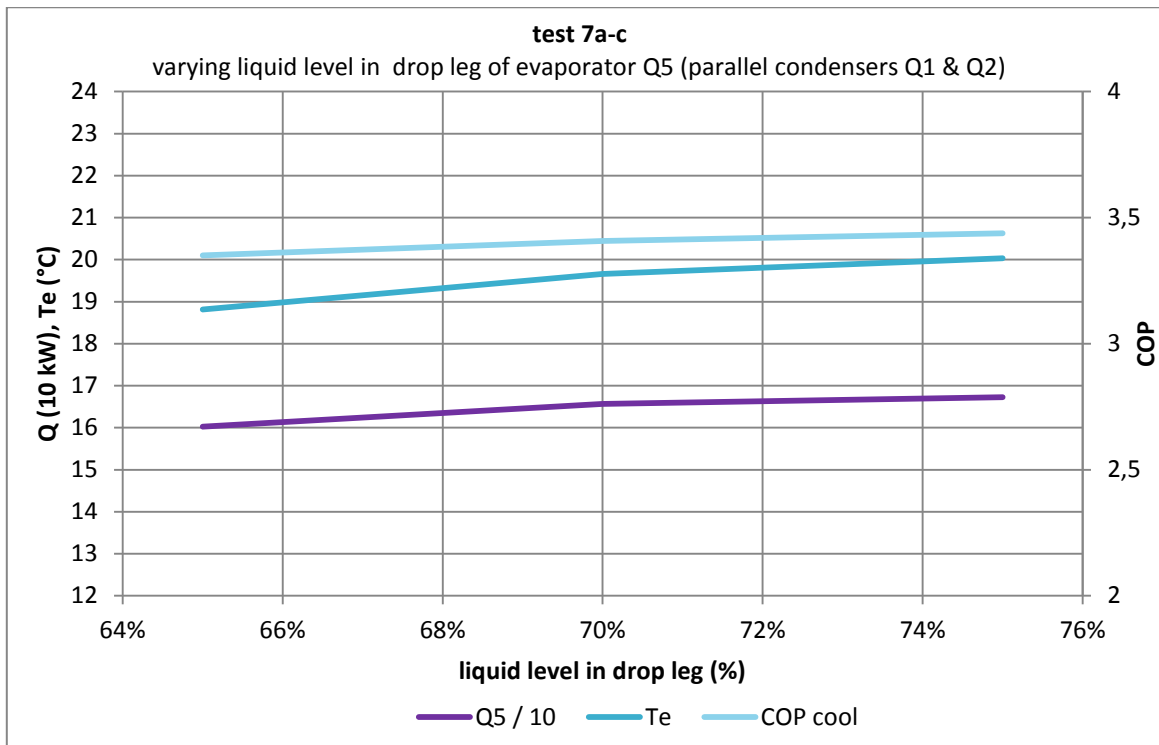

Figure 32: Results for different liquid levels in the drop leg

7.5.9. Test 6b: 48% Capacity, Pump Operation with Varying Differential Pressure

The operation with the liquid pump was tested at two different capacities. The results for the higher capacity are shown here. The tests were carried out with varying circulation ratio (varying pump flow) by regulating the differential pressure over the pump with a regulating valve after the pump. The pump nominal speed during these tests was 50Hz. The pump flow and the circulation rate are based on nominal pump data, see also pump characteristic in Appendix C. As can be seen in Figure 33, the evaporator capacity increases with increasing circulation ratio, but becomes fairly constant with ratios above approximately two. The tests have been carried out with constant water inlet temperature and water flow to the evaporator. The compressor was set to regulate the evaporating pressure at a constant value of 8.3bar (22.8°C saturation temperature).

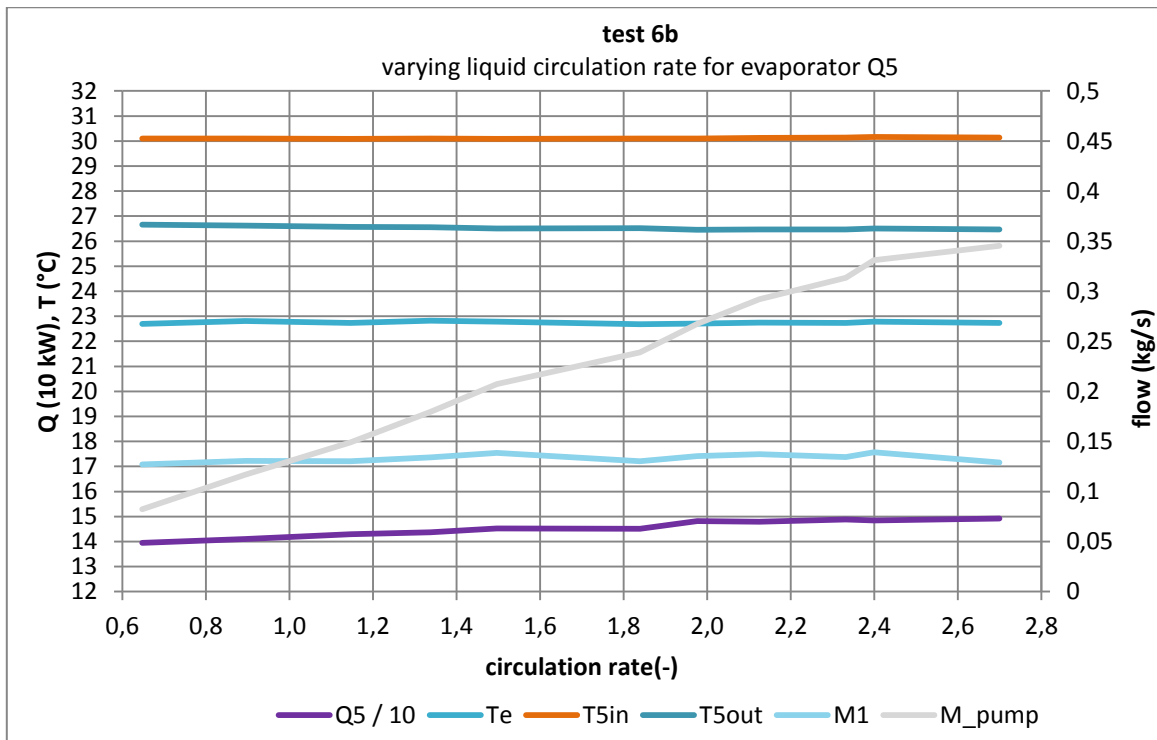

Figure 33: Results of test 6b, pump operation

7.6. Conclusion Regarding Test Results

The tests prove that it is possible to operate with both serial and parallel water flow over the two condensers without influencing the resulting mixed outlet temperature and with a constant COP factor.

Furthermore, the tests show that the use of the sub cooler and the oil & head cooler can increase the heating capacity and the COP factor considerably. It was not possible to obtain further sub-cooling of the refrigerant than approximately 20K, which is assumed to be related to an oil film in the sub cooler. The evaporating temperatures measured were also lower than the expected levels, again probably related to an oil film in the evaporator. The tests show that a heat pump has to exploit maximum advantage of sub-cooling to gain the highest possible COP.

A calculation made with the Mycom compressor calculation software shows that the tests carried out with a 60% capacity would have been expected to produce a COP of 4.7 instead of the measured COP of 4.3, if the evaporator and the sub cooler performance had been as intended (without the negative effect of the oil film). Similarly for the test carried out with a 33.3% capacity, a COP of 4.3 would have been expected instead of a COP of 4.0.

The tests with varying capacity over the two condensers show that the capacity and the temperature out of condenser (Q1) can be varied more or less independently of other factors; the mixed water temperature out of the heat pump, the COP factor, and the temperature out of condenser (Q2) all remain more or less constant.

The intention with tests 5 and 8 (parallel connection of the condensers) was to obtain water temperatures out of (Q1), which are significantly above the condensing temperature, while simultaneously keeping the mixed water outlet temperature at 80°C (mixing outlet of (Q1) and (Q2)). At the same time, it should be possible to vary the split of the load between (Q1) and (Q2). The tests show that with an equal inlet water temperature to both condensers the outlet temperatures and the load split can be varied to a great extent. The outlet temperature of (Q1) and the load split are related. Thus, they cannot be changed independently. The test results show that the water outlet temperature from (Q2) is nearly constant. The fact that the outlet water temperature for (Q2) remains nearly unchanged is due to the size of the heat exchangers and the low capacity during the test. The heat exchangers are laid out for small temperature approaches of approximately 1–1.5°C at full capacity. With the correct split of the condensers, it is possible to combine small temperature differences at a reduced total heat exchanger area.

The tests with varying liquid level in the drop leg show that the performance of the evaporator drops, when the liquid level is below the optimum level. Referring to section 5.3, a low liquid level corresponds to a low circulation rate. The tests show that under these particular tested conditions, a liquid level of 65% produced a mist in the evaporator outlet, which means that the heat transfer coefficients in the mist area were far lower than in the wetted area. The difference in performance between a liquid level of 70% and 75% is very little.

Tests with pump operation were limited due to the fact that they had to be run with the liquid level inside the U-turn, which it is not intended for. Nevertheless, a clear relation between the varying circulation ratio and the evaporator capacity can be seen. If the tests were run with constant water temperatures over the evaporator, the increased circulation ratio would relate to an increased evaporating temperature, which again would correspond to a lower power consumption and an improved COP-factor.

8. Final Discussion

The project has shown the potential of optimizing the heat pump performance and the efficiency by using sub cooling and by splitting up the condenser of a heat pump into two parts. A state of the art heat pump was built to test different concepts:

- Optimizing the COP by maximum utilization of the sub cooler and oil & cylinder head cooling
- Optimizing the total heat exchanger area and cost by an optimal split of the condenser parts
- Delivering a considerable amount of the total heat at a much higher temperature than the condensing temperature. The capacity and the temperature of this hot stream cannot be varied independently.

For the actual heat pump tested in the project, it was possible to heat water from 40°C to 80°C while cooling the heat sink from 30°C to 25°C with a COP of 4.3 (measured at 60% of the maximum compressor capacity). With the same total efficiency, it was possible to deliver approximately $\frac{1}{4}$ of the heat at 100°C and $\frac{3}{4}$ at 74°C. This coefficient of performance was reached with less sub cooling and at a lower evaporating temperature than expected, most probably due to an issue with an oil film on the evaporator and on the sub cooler plates. It is estimated that the COP-factor could have been 4.7, if the tests could have been carried out with the intended evaporating temperature and the intended amount of sub cooling.

It was not possible to test the heat pump at the maximum compressor capacity due to limitations of the combined operation of the liquid refrigerant pump and the U-turn separator.

The heat pump was also used to test the influence of pressure drop and circulation ratio on the capacity and the efficiency of the evaporator section. The optimum liquid level in the drop leg is important to assure that the plates in the evaporator are wetted completely and to avoid mist in the outlet section in that this will reduce the local heat transfer coefficient drastically. The optimum level varies with the capacity of the heat exchanger and it increases with increasing capacity.

The tests with operation of the refrigerant pump showed that the variation of the liquid flow and circulation ratio certainly influences the capacity and the efficiency. The test possibilities were limited by the fact that the pump operation had to be run with a liquid level inside the U-turn separator to assure stable operation. The U-turn is, however, not intended for this operation.

Appendix A – Detailed P&I Diagram

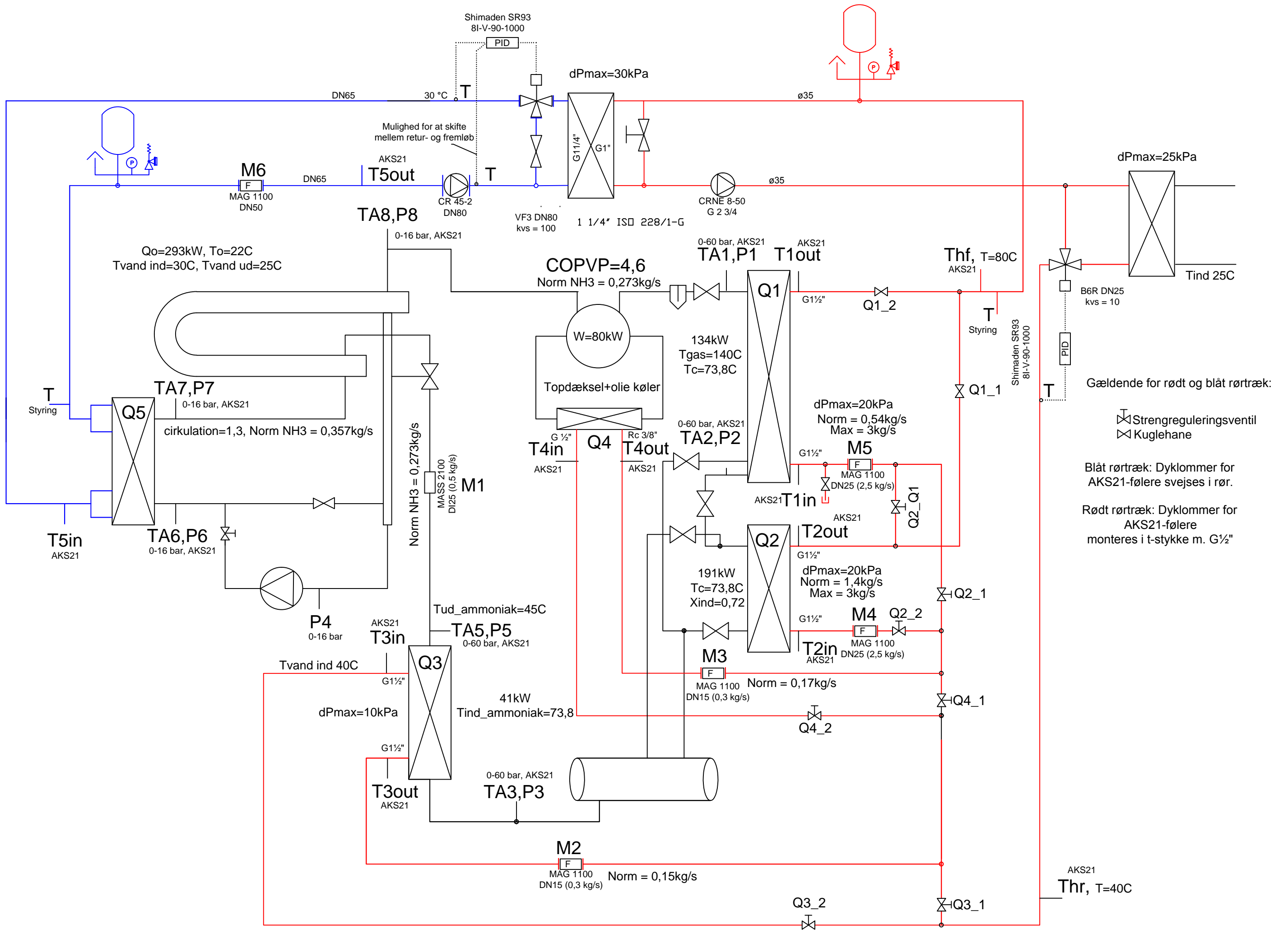

Gældende for rødt og blåt rørtræk:

- Strengreguleringsventil
- Kuglehane

Blåt rørtræk: Dyklommer for AKS21-følere svejses i rør.

Rødt rørtræk: Dyklommer for AKS21-følere monteres i t-stykke m. G1/2"

Appendix B - Test Results

General info

Mycom NGKK
compressor speed
capacity 20.0% 900
33.3% 1500
40.0% 900
60.0% 900
66.7% 1500
100.0% 1500

sample rate 25s

Table with 33 columns: P_1- to P_8-, M_1- to M_5-, phi_Q1 to phi_Q5, COP, EE, h_in_Q1 to h_out_Q, phi_R71, phi_R71, Spare, Spare, Spare, P_sup, T_disch, T_M, T_hr, T1_out, T1_in, T2_out, T2_in, T3_out, T3_in, T4_out, T4_in, T5_out, T5_in, TA_1- to TA_8-, T_sat, T_sat, T_ref.1, T_ref.1

Measurement 1)

Table with 33 columns: description, compressor capacity, cold water pump, hot water pump, file, date, time, no. of data points, average, standard dev., max, min, max - min

Measurement 2a)

Table with 33 columns: description, compressor capacity, cold water pump, hot water pump, file, date, time, no. of data points, average, standard dev., max, min, max - min

Measurement 2b)

Table with 33 columns: description, compressor capacity, cold water pump, hot water pump, file, date, time, no. of data points, average, standard dev., max, min, max - min

Measurement 2c)

Table with 33 columns: description, compressor capacity, cold water pump, hot water pump, file, date, time, no. of data points, average, standard dev., max, min, max - min

Measurement 2d)

Table with 33 columns: description, compressor capacity, cold water pump, hot water pump, file, date, time, no. of data points, average, standard dev., max, min, max - min

Measurement 3)

Table with 33 columns: description, compressor capacity, cold water pump, hot water pump, file, date, time, no. of data points, average, standard dev., max, min, max - min

Measurement 4)

description		parallel coupled condensers Q1 & Q2, 100degC out of Q1 and 80degC out combined, water flow for sub cooler Q3 and oil cooler Q4 adjusted to max. flow with hot water flow adjusted to have flow meter for M2 (sub cooler) in range (ca. 93-95%) as in measurement 2d)																																																							
compressor capacity	33.3%	liq. Level 65%																																																							
cold water pump	17 Hz																																																								
hot water pump	light 4 + 5																																																								
file	2013-06-04_svedamp_04.txt																																																								
date, time	2013-06-04, 14:38																																																								
no. of data points	14																																																								
average	35.79	35.78	35.74	9.32	35.82	9.22	9.26	9.30	0.09	0.25	0.12	0.53	0.21	18.20	49.16	66.38	9.88	2.98	103.51	3.95	3.19	1703.25	1489.92	523.55	366.86	366.86	1482.76	100.25	120.05	0.00	0.00	0.00	32.47	138.14	79.81	39.82	99.79	44.40	74.30	44.52	49.51	40.19	50.34	44.26	25.15	30.04	134.80	74.22	73.48	53.23	23.19	23.11	23.30	22.27	73.36	25.01	25.31
standard dev.	0.01	0.01	0.01	0.03	0.01	0.03	0.03	0.03	0.01	0.00	0.00	0.00	0.00	0.03	0.18	0.17	0.13	0.03	0.94	0.02	0.02	0.08	0.11	0.07	1.06	1.06	0.28	1.785	9.38	0.00	0.00	0.00	0.14	0.06	0.31	0.16	0.08	0.08	0.01	0.04	0.11	0.11	0.02	0.06	0.03	0.03	0.03	0.01	0.01	0.13	0.02	0.03	0.01	0.12	0.02	0.02	0.01
max	35.81	35.81	35.76	9.36	35.84	9.26	9.30	9.34	0.10	0.25	0.12	0.53	0.21	18.25	49.50	66.70	10.02	3.04	104.92	3.98	3.23	1703.36	1490.07	523.66	368.55	368.55	1483.17	112.00	134.07	0.00	0.00	0.00	32.65	138.24	80.15	40.16	99.91	44.51	74.31	44.58	49.68	40.41	50.38	44.37	25.20	30.08	134.85	74.23	73.50	53.43	23.22	23.17	23.38	22.41	73.40	25.03	25.34
min	35.76	35.76	35.71	9.27	35.79	9.18	9.22	9.26	0.08	0.25	0.12	0.53	0.21	18.14	48.84	66.14	9.60	2.93	102.28	3.93	3.14	1703.11	1489.74	523.38	365.51	365.51	1482.42	89.49	107.19	0.00	0.00	0.00	32.20	138.04	79.29	39.63	99.70	44.26	74.30	44.45	49.35	40.01	50.31	44.16	25.11	30.01	134.76	74.21	73.46	53.07	23.16	23.07	23.28	22.10	73.33	24.99	25.29
max - min	0.05	0.05	0.05	0.08	0.05	0.08	0.09	0.09	0.02	0.00	0.00	0.00	0.00	0.10	0.66	0.56	0.42	0.10	2.64	0.05	0.09	0.25	0.34	0.28	3.04	0.76	22.51	26.88	0.00	0.00	0.00	0.46	0.20	0.86	0.53	0.22	0.25	0.02	0.13	0.33	0.40	0.08	0.21	0.08	0.08	0.03	0.04	0.37	0.06	0.09	0.05	0.31	0.07	0.05	0.04		

Measurement 5a)

description		parallel coupled condensers Q1 & Q2, 0.16l/s Q1 and 0.59l/s Q2, water flow for sub cooler Q3 and oil cooler Q4 adjusted to max. flow with hot water flow adjusted to have flow meter for M2 (sub cooler) in range (ca. 93-95%) as in measurement 2d)																																																							
compressor capacity	33.3%	liq. Level 65%																																																							
cold water pump	17 Hz																																																								
hot water pump	light 4 + 5																																																								
file	2013-06-06_svedamp_05a.txt																																																								
date, time	2013-06-06, 13:41																																																								
no. of data points	12																																																								
average	36.13	36.14	36.08	9.36	36.16	9.26	9.30	9.34	0.09	0.25	0.12	0.59	0.15	18.23	39.38	73.84	9.91	3.22	103.53	3.88	3.18	1691.56	1489.53	527.61	370.40	370.40	1482.69	100.90	119.89	0.00	0.00	0.00	32.54	138.93	79.95	40.02	106.96	44.60	74.67	44.78	49.81	40.42	51.00	44.43	25.18	30.06	131.41	74.63	74.04	53.66	23.29	23.23	23.38	22.41	73.80	22.53	22.93
standard dev.	0.03	0.03	0.03	0.03	0.03	0.03	0.03	0.03	0.00	0.00	0.00	0.00	0.00	0.02	0.16	0.13	0.11	0.05	0.69	0.02	0.03	1.08	1.16	0.19	0.35	0.35	0.25	3.42	4.00	0.00	0.00	0.00	0.17	0.13	0.29	0.14	0.24	0.06	0.02	0.05	0.05	0.12	0.09	0.05	0.02	0.03	0.34	0.01	0.03	0.04	0.01	0.03	0.02	0.11	0.03	0.04	0.04
max	36.17	36.18	36.12	9.40	36.20	9.31	9.35	9.39	0.09	0.25	0.12	0.59	0.15	18.29	39.59	74.13	10.12	3.29	104.75	3.91	3.22	1693.26	1489.33	527.78	370.86	370.86	1483.09	105.30	125.03	0.00	0.00	0.00	32.87	139.13	80.36	40.18	107.41	44.69	74.69	44.86	49.87	40.57	51.11	44.49	25.22	30.12	131.84	74.65	74.07	53.71	23.31	23.28	23.41	22.57	73.85	22.58	22.99
min	36.10	36.10	36.04	9.31	36.13	9.22	9.26	9.30	0.09	0.25	0.12	0.59	0.15	18.20	39.10	73.68	9.80	3.17	102.75	3.84	3.13	1690.00	1489.33	527.18	369.62	369.62	1483.34	95.33	113.40	0.00	0.00	0.00	32.31	138.69	79.58	39.74	106.59	44.46	74.62	44.71	49.73	40.17	50.86	44.36	25.15	30.01	130.78	74.60	73.98	53.56	23.27	23.18	23.35	22.25	73.75	22.47	22.86
max - min	0.07	0.07	0.07	0.09	0.08	0.09	0.09	0.09	0.01	0.00	0.00	0.00	0.00	0.09	0.49	0.45	0.32	0.12	2.00	0.07	0.09	3.26	0.40	0.60	1.24	1.24	0.76	22.51	26.88	0.00	0.00	0.00	0.56	0.44	0.79	0.44	0.82	0.23	0.07	0.15	0.14	0.41	0.26	0.14	0.07	0.11	1.06	0.05	0.32	0.09	0.11	0.17	0.11	0.13			

Measurement 5b)

description		parallel coupled condensers Q1 & Q2, 0.13l/s Q1 and 0.62l/s Q2, water flow for sub cooler Q3 and oil cooler Q4 adjusted to max. flow with hot water flow adjusted to have flow meter for M2 (sub cooler) in range (ca. 93-95%) as in measurement 2d)																																																							
compressor capacity	33.3%	liq. Level 65%																																																							
cold water pump	17 Hz																																																								
hot water pump	light 4 + 5																																																								
file	2013-06-06_svedamp_05b.txt																																																								
date, time	2013-06-06, 13:52																																																								
no. of data points	19																																																								
average	36.07	36.09	36.03	9.34	36.11	9.25	9.29	9.33	0.09	0.25	0.12	0.61	0.13	18.23	36.70	77.05	10.04	2.98	103.58	3.90	3.19	1695.67	1489.65	527.25	369.83	369.83	1482.75	102.90	122.59	0.00	0.00	0.00	32.47	138.60	79.95	39.84	111.51	44.43	74.60	44.68	49.73	40.29	50.48	44.42	25.18	30.06	132.57	74.58	73.99	53.59	23.28	23.21	23.36	22.36	73.73	22.84	23.29
standard dev.	0.03	0.03	0.03	0.03	0.03	0.03	0.03	0.03	0.00	0.00	0.00	0.00	0.00	0.02	0.17	0.19	0.09	0.04	0.72	0.02	0.02	0.23	0.20	0.06	0.23	0.23	0.27	2.88	3.40	0.00	0.00	0.00	0.16	0.14	0.15	0.11	0.33	0.05	0.01	0.05	0.03	0.08	0.06	0.04	0.02	0.02	0.06	0.01	0.01	0.03	0.01	0.01	0.11	0.04	0.06	0.07	
max	36.12	36.13	36.07	9.39	36.15	9.30	9.34	9.38	0.10	0.26	0.12	0.62	0.13	18.27	37.09	77.36	10.14	3.07	105.05	3.95	3.24	1696.17	1489.95	527.34	370.37	370.37	1483.09	107.10	127.57	0.00	0.00	0.00	32.80	138.86	80.19	40.02	111.98	44.52	74.62	44.74	49.78	40.51	50.56	44.48	25.22	30.12	132.70	74.63	74.00	53.64	23.31	23.26	23.39	22.55	73.78	22.94	23.40
min	36.03	36.04	35.99	9.29	36.06	9.21	9.24	9.28	0.09	0.25	0.12	0.61	0.13	18.19	36.11	76.68	9.76	2.94	102.81	3.87	3.15	1695.22	1489.30	527.14	369.38	369.38	1482.32	95.77	114.12	0.00	0.00	0.00	32.02	138.39	79.69	39.67	110.84	44.36	74.59	44.61	49.69	40.20	50.38	44.33	25.15	30.03	132.45	74.56	73.98	53.53	23.26	23.17	23.34	22.20	73.67	22.74	23.18
max - min	0.09	0.08	0.08	0.10	0.09	0.10	0.10	0.10	0.01	0.00	0.00	0.00	0.00	0.08	0.98	0.68	0.37	0.13	2.24	0.08	0.09	0.95	0.64	0.20	0.89	0.89	0.77	13.33	13.44	0.00	0.00	0.00	0.79	0.47	0.50	0.35	1.13	0.16	0.03	0.13	0.09	0.31	0.18	0.15	0.07	0.09	0.25	0.04	0.03	0.11	0.06	0.09	0.05	0.34	0.11	0.20	0.21

Measurement 5c)

description		parallel coupled condensers Q1 & Q2, 0.21l/s Q1 and 0.53l/s Q2, water flow for sub cooler Q3 and oil cooler Q4 adjusted to max. flow with hot water flow adjusted to have flow meter for M2 (sub cooler) in range (ca. 93-95%) as in measurement 2d)																																																								
compressor capacity	33.3%	liq. Level 65%																																																								
cold water pump	17 Hz																																																									
hot water pump	light 4 + 5																																																									
file	2013-06-06_svedamp_05c.txt																																																									
date, time	2013-06-06, 14:15																																																									
no. of data points	12																																																									
average	36.05	36.07	36.01	9.30	36.08	9.21	9.25	9.29	0.09	0.25	0.12	0.54	0.20	18.25	48.27	67.31	9.96	2.90	103.30	3.97	3.20	1695.86	1489.49	526.76	370.02	370.02	1483.04	105.39	125.54	0.00	0.00	0.00	32.32	137.95	79.63	39.77	100.79	44.41	74.58	44.68	49.73	40.32	50.31	44.40	25.24	30.10	132.61	74.52	73.92	53.61	23.28	23.22	23.36	22.23	73.70	23.38	23.89	
standard dev.	0.01	0.01	0.01	0.01	0.01	0.01	0.01	0.01	0.00	0.00	0.00	0.00	0.00	0.02	0.20	0.02	0.01	0.17	0.05	0.05	0.31	0.31	0.03	0.35	0.35	0.42	3.15	3.61	0.00	0.00	0.00	0.11	0.06	0.23	0.06	0.08	0.02	0.01	0.01	0.03	0.05	0.01	0.03	0.01	0.01	0.01	0.01	0.01	0.01	0.01	0.01	0.01	0.01	0.01	0.01	0.01	0.01	0.01
max	36.07	36.09	36.03	9.31	36.10	9.22	9.26	9.30	0.10	0.25	0.12	0.54	0.21	18.27	48.60	67.44	10.06	2.93	103.66	4.00	3.21	1696.14	1489.55	526.85	370.46	370.46	1483.09	107.52	128.07	0.00	0.00	0.00	32.50	138.05	79.94	39.89	100.97	44.45	74.60	44.70	49.78	40.42	50.33	44.45	25.25	30.12	132.70	74.54	73.94	53.66	23.29	23.25	23.37	22.26	73.72	23.43	23.94	
min	36.03	36.05	35.99	9.29	36.06	9.20	9.24	9.28	0.09	0.25	0.12	0.54	0.20	18.23	47.96	67.23	9.90	2.88	103.02	3.95	3.18	1695.65	1489.40	526.69	369.55	369.55	1482.97	102.75	122.40	0.00	0.00	0.00	32.12	137.86	79.21	39.71	100.72	44.39	74.57	44.67	49.69	40.28	50.30	44.36	25.22	30.08	132.55	74.51	73.92	53.55	23.27	23.21	23.35	22.20	73.68	23.33	23.83	
max - min	0.04	0.04	0.04	0.02	0.04	0.02	0.02	0.02	0.00	0.00	0.00	0.00	0.00	0.04	0.64	0.21	0.16	0.04	0.64	0.																																						

description		parallel coupled condensers Q1 &Q2, 0,44l/s Q1 and 0,30l/s Q2, water flow for sub cooler Q3 and oil cooler Q4 adjusted to max. flow with hot water flow adjusted to have flow meter for M2 (sub cooler) in range (ca. 93-95%) as in measurement 2d)																																																							
compressor capacity		33,3%	liq. Level	65%																																																					
cold water pump		17 Hz																																																							
hot water pump		light 4 + 5																																																							
file		2013-06-06_svedamp_05g.txt																																																							
date, time		2013-06-06, 15:04																																																							
no. of data points		12																																																							
average	36,33	36,35	36,30	9,34	36,37	9,25	9,29	9,33	0,09	0,25	0,12	0,30	0,43	18,25	74,51	38,04	9,97	2,97	104,03	3,85	3,19	1698,91	1489,31	529,52	372,28	372,28	1483,00	98,45	117,59	0,00	0,00	0,00	32,61	138,88	79,47	40,04	86,33	44,59	75,04	44,70	50,01	40,42	50,57	44,42	25,25	30,15	133,87	74,87	74,31	53,88	23,25	23,23	23,44	22,36	74,05	23,83	24,39
standard dev.	0,01	0,01	0,01	0,04	0,01	0,04	0,04	0,04	0,00	0,00	0,00	0,00	0,00	0,02	0,17	0,11	0,05	0,03	0,75	0,01	0,03	0,26	0,09	0,07	0,47	0,47	0,29	4,05	4,79	0,00	0,00	0,00	0,10	0,04	0,29	0,08	0,03	0,06	0,02	0,03	0,05	0,06	0,02	0,04	0,03	0,03	0,08	0,02	0,01	0,06	0,01	0,02	0,01	0,13	0,02	0,01	0,01
max	36,37	36,38	36,33	9,39	36,40	9,29	9,33	9,37	0,09	0,25	0,12	0,30	0,43	18,27	74,78	38,18	10,08	3,00	104,94	3,87	3,23	1699,22	1489,48	529,62	373,31	373,31	1483,36	104,57	124,83	0,00	0,00	0,00	32,83	138,94	79,97	40,14	86,37	44,72	75,07	44,75	50,09	40,53	50,60	44,52	25,28	30,18	133,95	74,91	74,32	54,01	23,28	23,26	23,45	22,52	74,10	23,84	24,40
min	36,31	36,33	36,27	9,29	36,35	9,19	9,24	9,27	0,08	0,25	0,12	0,30	0,43	18,20	74,25	37,83	9,92	2,91	102,81	3,83	3,13	1698,41	1489,17	529,39	371,75	371,75	1482,59	94,26	112,62	0,00	0,00	0,00	32,47	138,80	79,05	39,88	86,29	44,48	75,01	44,67	49,91	40,33	50,54	44,37	25,20	30,10	133,74	74,83	74,29	53,82	23,24	23,19	23,42	22,17	74,03	23,82	24,38
max - min	0,06	0,05	0,06	0,10	0,05	0,10	0,10	0,10	0,01	0,00	0,00	0,00	0,00	0,08	0,53	0,35	0,16	0,09	2,13	0,04	0,10	0,81	0,31	0,23	1,56	1,56	0,78	10,31	12,20	0,00	0,00	0,00	0,36	0,14	0,92	0,27	0,08	0,24	0,06	0,09	0,18	0,20	0,06	0,15	0,08	0,08	0,25	0,07	0,03	0,19	0,04	0,07	0,03	0,35	0,07	0,02	0,02

Measurement 5b)																																																										
description		parallel coupled condensers Q1 &Q2, 0,52l/s Q1 and 0,22l/s Q2, water flow for sub cooler Q3 and oil cooler Q4 adjusted to max. flow with hot water flow adjusted to have flow meter for M2 (sub cooler) in range (ca. 93-95%) as in measurement 2d)																																																								
compressor capacity		33,3%	liq. Level	65%																																																						
cold water pump		17 Hz																																																								
hot water pump		light 4 + 5																																																								
file		2013-06-06_svedamp_05h.txt																																																								
date, time		2013-06-06, 15:15																																																								
no. of data points		8																																																								
average	36,09	36,11	36,06	9,37	36,13	9,27	9,31	9,35	0,09	0,25	0,12	0,21	0,52	18,22	86,61	26,62	10,01	2,93	104,05	3,88	3,20	1700,29	1489,43	527,64	370,61	370,61	1483,73	99,14	118,54	0,00	0,00	0,00	32,50	138,48	79,86	39,87	84,15	44,65	74,75	44,68	49,83	40,28	50,49	44,47	25,21	30,12	134,11	74,57	74,05	53,68	23,26	23,16	23,42	22,44	73,75	23,81	24,39	
standard dev.	0,02	0,02	0,02	0,03	0,02	0,03	0,03	0,03	0,00	0,00	0,00	0,00	0,00	0,02	0,14	0,04	0,06	0,02	0,82	0,02	0,02	0,10	0,09	0,04	0,56	0,56	0,19	3,80	4,53	0,00	0,00	0,00	0,14	0,04	0,17	0,11	0,02	0,05	0,01	0,02	0,07	0,07	0,01	0,04	0,01	0,03	0,02	0,01	0,01	0,01	0,07	0,02	0,02	0,01	0,10	0,03	0,00	0,01
max	36,12	36,14	36,09	9,40	36,16	9,30	9,34	9,38	0,09	0,25	0,12	0,21	0,52	18,24	86,70	26,68	10,13	2,97	104,94	3,92	3,23	1700,49	1489,57	527,71	371,54	371,54	1483,11	105,30	125,88	0,00	0,00	0,00	32,70	138,55	80,09	39,98	84,19	44,74	74,76	44,71	49,93	40,36	50,51	44,53	25,24	30,16	134,13	74,59	74,06	53,79	23,28	23,19	23,43	22,54	73,79	23,81	24,40	
min	36,06	36,07	36,02	9,31	36,10	9,22	9,26	9,30	0,09	0,25	0,12	0,21	0,52	18,19	86,30	26,56	9,93	2,90	102,77	3,86	3,18	1700,19	1489,32	527,59	369,81	369,81	1482,53	94,75	113,29	0,00	0,00	0,00	32,24	138,40	79,59	39,71	84,12	44,60	74,74	44,64	49,72	40,19	50,47	44,38	25,20	30,08	134,09	74,55	74,04	53,59	23,24	23,14	23,41	22,26	73,70	23,81	24,38	
max - min	0,07	0,07	0,07	0,08	0,07	0,08	0,08	0,08	0,01	0,00	0,00	0,00	0,00	0,05	0,41	0,12	0,20	0,07	2,17	0,06	0,05	0,25	0,25	0,12	1,72	1,72	0,58	10,55	12,59	0,00	0,00	0,00	0,46	0,15	0,50	0,26	0,08	0,14	0,02	0,07	0,21	0,17	0,04	0,15	0,04	0,08	0,04	0,04	0,02	0,21	0,04	0,05	0,03	0,28	0,09	0,00	0,02	

Measurement 5i)																																																									
description		parallel coupled condensers Q1 &Q2, 0,60l/s Q1 and 0,14l/s Q2, water flow for sub cooler Q3 and oil cooler Q4 adjusted to max. flow with hot water flow adjusted to have flow meter for M2 (sub cooler) in range (ca. 93-95%) as in measurement 2d)																																																							
compressor capacity		33,3%	liq. Level	65%																																																					
cold water pump		17 Hz																																																							
hot water pump		light 4 + 5																																																							
file		2013-06-06_svedamp_05i.txt																																																							
date, time		2013-06-06, 15:25																																																							
no. of data points		10																																																							
average	35,79	35,81	35,76	9,31	35,83	9,22	9,26	9,30	0,09	0,25	0,12	0,14	0,60	18,24	96,06	17,38	9,85	2,94	103,71	3,90	3,21	1700,57	1489,68	525,09	368,95	368,95	1483,12	103,64	123,86	0,00	0,00	0,00	32,35	137,78	80,14	39,94	82,56	44,58	74,35	44,55	49,66	40,39	50,31	44,36	25,24	30,12	133,92	74,20	73,69	53,48	23,23	23,17	23,40	22,25	73,37	23,87	24,48
standard dev.	0,01	0,02	0,01	0,03	0,01	0,03	0,02	0,03	0,00	0,00	0,00	0,00	0,00	0,02	0,31	0,11	0,09	0,03	0,71	0,02	0,03	0,08	0,08	0,06	0,52	0,52	0,21	2,60	3,10	0,00	0,00	0,00	0,12	0,06	0,10	0,14	0,02	0,09	0,01	0,02	0,05	0,11	0,02	0,06	0,03	0,04	0,02	0,01	0,01	0,06	0,02	0,04	0,02	0,09	0,02	0,01	0,01
max	35,82	35,85	35,79	9,36	35,87	9,26	9,30	9,34	0,10	0,25	0,12	0,14	0,61	18,27	96,05	17,31	9,97	2,99	105,16	3,93	3,25	1700,69	1489,74	525,20	369,79	369,79	1483,39	107,04	127,91	0,00	0,00	0,00	32,65	137,91	80,33	40,17	82,59	44,66	74,37	44,57	49,76	40,58	50,35	44,43	25,27	30,20	133,95	74,23	73,71	53,58	23,25	23,22	23,44	22,40	73,41	23,88	24,50
min	35,78	35,80	35,74	9,27	35,82	9,18	9,22	9,26	0,09	0,25	0,12	0,14	0,60	18,20	95,49	17,20	9,70	2,89	102,88	3,86	3,17	1700,39	1489,48	524,99	368,20	368,20	1482,81	99,41	118,94	0,00	0,00	0,00	32,25	137,72	80,02	39,77	82,53	44,40	74,35	44,50	49,59	40,25	50,28	44,26	25,19	30,08	133,89	74,18	73,68	53,39	23,19	23,12	23,38	22,12	73,35	23,85	24,46
max - min	0,05	0,05	0,05	0,08	0,05	0,08	0,08	0,08	0,01	0,00	0,00	0,00	0,00	0,07	1,17	0,31	0,27	0,10	2,28	0,06	0,08	0,30	0,27	0,21	1,59	1,59	0,58	7,63	9,07	0,00	0,00	0,00	0,40	0,19	0,32	0,39	0,05	0,26	0,02	0,07	0,17	0,33	0,07	0,17	0,08	0,12	0,06	0,04	0,03	0,19	0,06	0,10	0,05	0,29	0,06	0,03	0,04

Measurement 5j)																																																									
description		parallel coupled condensers Q1 &Q2, 0,66l/s Q1 and 0,08l/s Q2, water flow for sub cooler Q3 and oil cooler Q4 adjusted to max. flow with hot water flow adjusted to have flow meter for M2 (sub cooler) in range (ca. 93-95%) as in measurement 2d)																																																							
compressor capacity		33,3%	liq. Level	65%																																																					
cold water pump		17 Hz																																																							
hot water pump		light 4 + 5																																																							
file		2013-06-06_svedamp_05j.txt																																																							
date, time		2013-06-06, 15:40																																																							
no. of data points		11																																																							
average	35,72	35,74	35,69	9,32	35,76	9,23	9,27	9,31	0,09	0,25	0,12	0,08	0,66	18,22	103,55	10,13	9,88	2,90	103,92	3,91	3,22	1701,13	1489,68	524,74	368,25	368,25	1482,95	103,00	123,16	0,00	0,00	0,00	32,31	137,77	80,60	39,88	81,75	44,54	74,24	44,46	49,59	40,32	50,21	44,35	25,20	30,10	134,04	74,11	73,65	53,40	23,20	23,12	23,38	22,29	73,28	23,98	24,59
standard dev.	0,02	0,02	0,02	0,04	0,02	0,04	0,04	0,04	0,00	0,00	0,00	0,00	0,00	0,04	0,18	0,05	0,09	0,03	0,70	0,02	0,02	0,08	0,06	0,10	0,46	0,46	0,32	3,93	4,68	0,00	0,00	0,00	0,18	0,10	0,03	0,13	0,03	0,05	0,01	0,04	0,05	0,09	0,02	0,07	0,03	0,02	0,02	0,02	0,01	0,14	0,02	0,01	0,01				
max	35,75	35,77	35,72	9,38	35,79	9,28	9,32	9,36	0,10	0,26	0,12	0,08	0,67	18,28	103,88	10,20	10,00	2,93	105,34	3,95	3,25	1701,24	1489,80	524,86	368,90	368,90	1483,40	107,95	129,05	0,00	0,00	0,00	32,73	137,92	80,63	40,06	81,78	44,61	74,26	44,51	49,67	40,47	50,26	44,46	25,25	30,15	134,07	74,13	73,66	53,48	23,22	23,15	23,39	22,47	73,31	24,00	24,60
min	35,70	35,72	35,66	9,27	35,74	9,18	9,22	9,26	0,08	0,25	0,12	0,08	0,66	18,17	103,27	10,05	9,71	2,85	103,09	3,86	3,18	1700,98	1489,60	524,56	367,68	367,68	1482,58	94,55	113,07	0,00	0,00	0,00	32,09	137,62	80,55	39,70	81,69	44,41	74,22	44,40	49,52	40,21	50,18	44,27	25,16	30,08	134,00	74,09	73,62	53,33	23,17	23,09	23,36	22,10	73,25	23,97	24,58
max - min	0,05	0,05	0,05	0,10	0,05	0,10	0,11	0,11	0,01	0,00	0,00	0,00	0,00	0,10	0,60	0,15	0,29	0,08	2,25	0,08	0,07	0,26	0,19</																																		

description	parallel coupled condensers Q1 & Q2, 100degC out of Q1 and 80degC out combined, water flow for sub cooler Q3 and oil cooler Q4 with same adjustment as measurement 4) - 65% liquid level																																																								
compressor capacity	60.0%	liq. Level 65%																																																							
cold water pump	29.5 Hz																																																								
hot water pump	not noted																																																								
file	2013-06-10_01_svedanvp_07.txt																																																								
date, time	2013-06-10, 10:24																																																								
no. of data points	46																																																								
average	36.19	36.20	36.14	8.39	36.21	8.29	8.33	8.36	0.15	0.40	0.19	0.87	0.30	30.72	70.58	107.86	13.64	4.96	160.25	4.12	3.35	1704.04	1489.44	503.46	358.56	358.56	1485.89	165.60	197.65	0.00	0.00	0.00	47.84	138.61	79.53	40.14	100.52	44.53	74.40	44.67	48.89	40.70	50.72	44.33	25.57	30.05	135.43	74.69	70.76	52.24	19.81	19.90	21.83	18.81	73.87	23.59	24.25
standard dev.	0.05	0.05	0.05	0.04	0.05	0.04	0.04	0.04	0.00	0.00	0.00	0.00	0.00	0.05	0.25	0.20	0.35	0.06	0.85	0.02	0.02	0.30	0.34	0.19	0.95	0.95	0.30	2.75	3.28	0.00	0.00	0.00	0.18	0.05	0.19	0.19	0.08	0.08	0.01	0.04	0.10	0.15	0.04	0.07	0.04	0.03	0.08	0.02	0.03	0.11	0.02	0.03	0.01	0.14	0.06	0.02	0.02
max	36.27	36.28	36.23	8.46	36.29	8.36	8.40	8.43	0.15	0.40	0.19	0.87	0.30	30.83	71.23	108.39	14.18	5.07	161.62	4.16	3.38	1704.62	1490.00	503.80	360.50	360.50	1486.42	170.75	203.80	0.00	0.00	0.00	48.21	138.70	79.88	40.53	100.68	44.71	74.44	44.77	49.09	41.00	50.79	44.49	25.64	30.11	135.58	74.73	70.81	52.47	19.85	19.95	21.86	19.07	73.98	23.62	24.29
min	36.10	36.11	36.04	8.32	36.12	8.23	8.27	8.30	0.14	0.40	0.18	0.86	0.30	30.63	70.05	107.44	13.03	4.80	158.80	4.08	3.31	1703.65	1488.91	503.13	356.71	356.71	1485.34	159.83	190.87	0.00	0.00	0.00	47.39	138.54	79.18	39.83	100.36	44.38	74.38	44.60	48.71	40.43	50.64	44.19	25.49	29.99	135.26	74.65	70.72	52.02	19.76	19.84	21.81	18.57	73.76	23.56	24.21
max - min	0.18	0.17	0.18	0.14	0.17	0.13	0.13	0.13	0.01	0.00	0.00	0.00	0.00	0.19	1.17	0.95	1.15	0.27	2.82	0.09	0.07	1.17	1.10	0.67	3.79	3.79	1.08	10.82	12.93	0.00	0.00	0.00	0.83	0.16	0.70	0.70	0.31	0.32	0.06	0.18	0.38	0.57	0.15	0.30	0.15	0.12	0.30	0.08	0.09	0.45	0.09	0.11	0.05	0.50	0.22	0.06	0.07

description	parallel coupled condensers Q1 & Q2, 100degC out of Q1 and 80degC out combined, water flow for sub cooler Q3 and oil cooler Q4 with same adjustment as measurement 4) - 70% liquid level																																																								
compressor capacity	60.0%	liq. Level 70%																																																							
cold water pump	29.5 Hz																																																								
hot water pump	not noted																																																								
file	2013-06-10_01_svedanvp_07.txt																																																								
date, time	2013-06-10, 10:36																																																								
no. of data points	39																																																								
average	36.50	36.50	36.45	8.61	36.52	8.52	8.56	8.59	0.15	0.41	0.19	0.88	0.32	30.69	72.95	110.29	13.81	4.79	165.65	4.15	3.41	1699.41	1489.08	501.49	358.11	358.11	1483.38	171.95	204.92	0.00	0.00	0.00	48.60	136.66	79.59	40.17	99.46	44.49	74.62	44.61	48.87	40.74	50.39	44.34	25.42	30.06	134.09	75.04	70.50	52.19	20.68	20.58	21.59	19.66	74.26	23.85	24.53
standard dev.	0.07	0.07	0.07	0.04	0.07	0.04	0.04	0.04	0.00	0.00	0.00	0.00	0.00	0.05	0.20	0.15	0.44	0.08	1.00	0.04	0.02	0.67	0.48	0.29	2.19	2.19	0.35	6.09	7.22	0.00	0.00	0.00	0.15	0.27	0.27	0.17	0.50	0.10	0.17	0.06	0.19	0.13	0.09	0.08	0.04	0.04	0.19	0.04	0.44	0.26	0.06	0.07	0.02	0.16	0.08	0.01	0.01
max	36.62	36.63	36.58	8.71	36.65	8.61	8.64	8.67	0.17	0.41	0.19	0.88	0.32	30.79	73.86	110.89	14.50	4.96	167.39	4.20	3.44	1700.37	1489.95	505.26	360.94	360.94	1484.02	186.86	222.51	0.00	0.00	0.00	48.88	137.01	80.01	40.48	99.93	44.69	74.74	44.74	49.16	40.97	50.56	44.49	25.49	30.11	134.39	75.09	71.01	52.52	20.81	20.73	21.62	19.99	74.02	23.88	24.55
min	36.36	36.36	36.31	8.54	36.38	8.44	8.48	8.51	0.14	0.40	0.19	0.87	0.31	30.57	71.18	108.28	12.82	4.59	163.81	4.05	3.37	1697.92	1488.06	492.67	352.55	352.55	1482.73	161.88	193.08	0.00	0.00	0.00	48.28	135.99	78.98	39.87	98.22	44.29	74.09	44.47	48.42	40.49	50.20	44.18	25.32	30.00	133.79	74.89	69.31	51.53	20.55	20.44	21.55	19.39	74.09	23.83	24.50
max - min	0.26	0.27	0.27	0.17	0.28	0.16	0.16	0.16	0.02	0.00	0.00	0.00	0.00	0.22	2.68	2.61	1.68	0.37	3.58	0.15	0.07	2.45	1.90	12.58	8.38	8.38	1.29	24.98	29.43	0.00	0.00	0.00	0.60	1.02	1.03	0.61	1.71	0.41	0.65	0.26	0.74	0.49	0.35	0.31	0.17	0.11	0.60	0.21	1.70	1.00	0.26	0.29	0.08	0.60	0.33	0.05	0.05

description	parallel coupled condensers Q1 & Q2, 100degC out of Q1 and 80degC out combined, water flow for sub cooler Q3 and oil cooler Q4 with same adjustment as measurement 4) - 75% liquid level																																																								
compressor capacity	60.0%	liq. Level 75%																																																							
cold water pump	29.5 Hz																																																								
hot water pump	not noted																																																								
file	2013-06-10_01_svedanvp_07.txt																																																								
date, time	2013-06-10, 10:49																																																								
no. of data points	43																																																								
average	36.39	36.39	36.34	8.71	36.40	8.62	8.65	8.68	0.15	0.41	0.19	0.90	0.31	30.68	73.02	111.92	15.64	4.84	167.26	4.22	3.44	1699.45	1489.33	521.04	367.20	367.20	1482.36	167.31	199.88	0.00	0.00	0.00	48.66	136.27	79.72	40.08	100.35	44.71	74.63	44.86	49.70	40.63	50.59	44.57	25.38	30.06	134.10	74.94	73.15	53.27	20.99	20.92	21.52	20.03	74.13	24.02	24.70
standard dev.	0.08	0.08	0.08	0.04	0.08	0.04	0.04	0.04	0.00	0.00	0.00	0.00	0.00	0.05	0.27	0.26	0.39	0.06	0.79	0.03	0.01	0.32	0.51	0.49	0.92	0.92	0.33	2.77	3.31	0.00	0.00	0.00	0.18	0.08	0.23	0.22	0.08	0.07	0.04	0.03	0.09	0.19	0.03	0.06	0.04	0.04	0.08	0.03	0.07	0.11	0.03	0.04	0.02	0.15	0.10	0.01	0.02
max	36.53	36.54	36.48	8.78	36.54	8.69	8.72	8.75	0.16	0.41	0.19	0.90	0.32	30.77	73.74	112.62	16.44	4.96	168.55	4.27	3.47	1700.32	1490.33	521.94	369.11	369.11	1482.90	175.33	209.41	0.00	0.00	0.00	49.08	136.45	80.21	40.49	100.54	44.83	74.73	44.94	49.92	40.94	50.64	44.68	25.45	30.12	134.25	75.00	73.27	53.50	21.04	20.98	21.55	20.27	74.30	24.05	24.73
min	36.19	36.20	36.15	8.65	36.21	8.56	8.59	8.62	0.15	0.41	0.19	0.89	0.31	30.59	72.35	111.45	14.96	4.73	166.04	4.17	3.42	1698.76	1488.41	520.17	365.14	365.14	1481.85	162.23	193.75	0.00	0.00	0.00	48.33	136.14	79.20	39.67	100.24	44.57	74.57	44.79	49.53	40.29	50.53	44.44	25.31	30.00	133.95	74.87	73.03	53.03	20.94	20.86	21.48	19.80	73.88	24.00	24.68
max - min	0.33	0.33	0.33	0.13	0.33	0.13	0.12	0.13	0.01	0.00	0.00	0.01	0.01	0.19	1.40	1.17	1.48	0.22	2.51	0.10	0.05	1.36	1.91	1.77	3.97	3.97	1.40	13.10	15.66	0.00	0.00	0.00	0.75	0.31	1.01	0.81	0.30	0.27	0.16	0.15	0.39	0.66	0.12	0.24	0.14	0.12	0.30	0.13	0.24	0.48	0.09	0.13	0.07	0.47	0.42	0.05	0.05

description	serial coupled condensers Q1 & Q2, 80degC out combined, water flow for sub cooler Q3 and oil cooler Q4 with same adjustment as measurement 4) - 75% liquid level																																																								
compressor capacity	60.0%	liq. Level 75%																																																							
cold water pump	29.5 Hz																																																								
hot water pump	not noted																																																								
file	2013-06-10_01_svedanvp_07.txt																																																								
date, time	2013-06-10, 11:17																																																								
no. of data points	52																																																								
average	35.46	35.46	35.39	8.69	35.46	8.59	8.63	8.66	0.15	0.42	0.20	1.25	1.26	30.63	37.11	149.09	15.37	4.38	168.19	4.30	3.51	1692.48	1490.04	515.98	364.31	364.31	1482.18	170.05	202.04	0.00	0.00	0.00	47.93	133.40	80.03	40.20	80.06	73.02	73.15	44.73	49.45	40.76	49.88	44.57	25.26	29.98	130.95	73.79	72.45	52.92	20.89	20.82	21.39	19.93	72.94	24.30	24.95
standard dev.	0.05	0.05	0.05	0.04	0.05	0.04	0.04	0.04	0.00	0.00	0.00	0.00	0.00	0.06	0.10	0.29	0.30	0.07	0.76	0.02	0.02	0.32	0.31	0.58	0.95	0.95	0.35	2.51	2.96	0.00	0.00	0.00	0.14	0.06	0.02	0.16	0.02	0.02	0.02	0.04	0.09	0.12	0.04	0.04	0.04	0.08	0.02	0.08	0.11	0.03	0.04	0.03	0.15	0.06	0.01	0.01	
max	35.54	35.54	35.47	8.76	35.54	8.66	8.70	8.73	0.16	0.42	0.20	1.26	1.26	30.73	37.34	149.65	15.90	4.52	169.46	4.33	3.54	1693.17	1490.75	516.82	366.07	366.07	1482.80	175.17	208.10	0.00	0.00	0.00	48.24	133.53	80.08	40.49	80.09	73.																			

compressor capacity	60,0%	liq. Level 75%																																																								
cold water pump	29,5 Hz																																																									
hot water pump	not noted																																																									
file	2013-06-10_01_svedanvp_08.txt																																																									
date, time	2013-06-10, 13:33																																																									
no. of data points	46																																																									
average	36,67	36,69	36,63	8,69	36,70	8,59	8,63	8,66	0,15	0,40	0,19	0,57	0,60	30,69	109,44	72,08	16,03	4,86	165,19	4,15	3,39	1699,83	1489,07	529,94	372,36	372,36	1482,52	162,25	194,01	0,00	0,00	0,00	48,77	137,03	79,48	40,00	88,48	44,88	75,30	45,00	50,16	40,54	50,94	44,68	25,44	30,07	134,49	75,30	74,37	53,89	20,92	20,84	21,50	19,93	74,48	25,36	25,81	
standard dev.	0,06	0,06	0,06	0,04	0,06	0,04	0,04	0,04	0,00	0,00	0,00	0,00	0,00	0,00	0,05	0,33	0,17	0,34	0,06	0,86	0,02	0,01	0,29	0,40	0,24	0,75	0,75	0,35	2,14	2,55	0,00	0,00	0,00	0,15	0,06	0,17	0,17	0,05	0,08	0,02	0,03	0,08	0,13	0,03	0,05	0,04	0,04	0,07	0,02	0,03	0,09	0,02	0,04	0,03	0,15	0,08	0,01	0,01
max	36,77	36,78	36,73	8,75	36,79	8,66	8,69	8,73	0,15	0,40	0,19	0,57	0,60	30,79	110,12	72,39	16,54	4,95	166,61	4,19	3,42	1700,44	1489,68	530,23	374,21	374,21	1483,03	166,52	199,15	0,00	0,00	0,00	49,11	137,11	79,76	40,29	88,56	45,01	75,33	45,05	50,32	40,79	51,02	44,78	25,52	30,14	134,61	75,33	74,41	54,12	20,86	20,90	21,55	20,18	74,60	25,38	25,82	
min	36,58	36,59	36,54	8,63	36,60	8,53	8,56	8,60	0,14	0,40	0,18	0,57	0,60	30,58	108,92	71,67	15,46	4,76	163,92	4,10	3,36	1699,26	1488,45	529,40	371,31	371,31	1481,92	157,65	188,52	0,00	0,00	0,00	48,49	136,90	79,12	39,73	88,41	44,77	75,25	44,95	50,04	40,35	50,89	44,60	25,37	30,01	134,33	75,24	74,29	53,77	20,88	20,77	21,45	19,70	74,37	25,34	25,79	
max - min	0,19	0,19	0,19	0,13	0,20	0,13	0,13	0,13	0,01	0,00	0,00	0,00	0,01	0,20	1,20	0,72	1,09	0,19	2,69	0,08	0,06	1,18	1,24	0,83	2,90	2,90	1,11	8,87	10,64	0,00	0,00	0,00	0,62	0,21	0,65	0,56	0,14	0,25	0,07	0,10	0,28	0,44	0,13	0,18	0,15	0,13	0,28	0,09	0,11	0,35	0,08	0,13	0,10	0,48	0,23	0,04	0,03	

Measurement 8d)																																																									
description	parallel coupled condensers Q1 & Q2, 0,76l/s Q1 and 0,42l/s Q2, water flow for sub cooler Q3 and oil cooler Q4 as in measurement 7a)																																																								
compressor capacity	60,0%	liq. Level 75%																																																							
cold water pump	29,5 Hz																																																								
hot water pump	not noted																																																								
file	2013-06-10_01_svedanvp_08.txt																																																								
date, time	2013-06-10, 13:43																																																								
no. of data points	54																																																								
average	36,43	36,44	36,39	8,68	36,46	8,58	8,61	8,65	0,15	0,40	0,19	0,42	0,76	30,67	128,31	52,84	16,02	4,83	165,35	4,16	3,40	1700,11	1489,27	529,31	371,64	371,64	1482,53	164,68	196,93	0,00	0,00	0,00	48,61	136,69	79,94	40,04	85,32	44,89	75,11	44,99	50,09	40,59	50,86	44,70	25,44	30,07	134,36	75,00	74,28	53,81	20,87	20,79	21,47	19,89	74,18	25,41	25,83
standard dev.	0,07	0,07	0,07	0,04	0,07	0,04	0,04	0,04	0,00	0,00	0,00	0,00	0,00	0,05	0,43	0,13	0,38	0,07	0,83	0,02	0,01	0,22	0,42	0,09	1,00	1,00	0,34	2,73	3,26	0,00	0,00	0,00	0,16	0,02	0,17	0,19	0,03	0,09	0,01	0,04	0,10	0,15	0,03	0,06	0,05	0,04	0,03	0,01	0,12	0,02	0,04	0,02	0,15	0,08	0,00	0,00	
max	36,54	36,55	36,50	8,74	36,57	8,65	8,68	8,71	0,15	0,40	0,19	0,42	0,76	30,75	129,38	53,14	16,68	4,94	166,83	4,19	3,43	1700,49	1489,94	529,47	373,88	373,88	1483,07	171,97	205,62	0,00	0,00	0,00	49,04	136,73	80,42	40,36	85,38	45,05	75,14	45,06	50,31	40,84	50,93	44,84	25,52	30,14	134,42	75,05	74,30	54,08	20,92	20,86	21,53	20,13	74,31	25,41	25,84
min	36,31	36,32	36,28	8,62	36,34	8,52	8,55	8,59	0,14	0,40	0,19	0,42	0,75	30,58	127,49	52,55	15,44	4,69	163,97	4,11	3,37	1699,75	1488,63	529,09	369,76	369,76	1481,93	160,61	192,08	0,00	0,00	0,00	48,35	136,66	79,66	39,71	85,27	44,73	75,09	44,91	49,91	40,33	50,78	44,56	25,36	30,00	134,30	74,95	74,25	53,58	20,83	20,72	21,42	19,66	74,02	25,41	25,82
max - min	0,23	0,22	0,22	0,12	0,23	0,13	0,12	0,12	0,01	0,00	0,00	0,00	0,01	0,17	1,89	0,59	1,24	0,25	2,86	0,08	0,07	0,74	1,31	0,37	4,12	4,12	1,14	13,35	13,54	0,00	0,00	0,00	0,70	0,07	0,75	0,64	0,10	0,33	0,04	0,16	0,39	0,51	0,15	0,28	0,16	0,14	0,12	0,11	0,05	0,50	0,09	0,15	0,09	0,46	0,29	0,01	0,01

Measurement 8e)																																																									
description	parallel coupled condensers Q1 & Q2, 0,89l/s Q1 and 0,31l/s Q2, water flow for sub cooler Q3 and oil cooler Q4 as in measurement 7a)																																																								
compressor capacity	60,0%	liq. Level 75%																																																							
cold water pump	29,5 Hz																																																								
hot water pump	not noted																																																								
file	2013-06-10_01_svedanvp_08.txt																																																								
date, time	2013-06-10, 13:53																																																								
no. of data points	60																																																								
average	35,98	35,99	35,95	8,64	36,01	8,55	8,58	8,61	0,15	0,41	0,19	0,31	0,89	30,66	142,46	38,28	15,90	4,82	165,47	4,18	3,44	1699,66	1489,58	526,28	368,94	368,94	1482,58	166,26	198,67	0,00	0,00	0,00	48,15	135,93	79,99	39,99	83,09	44,74	74,60	44,82	49,82	40,53	50,60	44,56	25,42	30,06	133,79	74,43	73,86	53,48	20,75	20,67	21,40	19,77	73,61	25,41	25,81
standard dev.	0,06	0,06	0,06	0,04	0,06	0,04	0,04	0,04	0,00	0,00	0,00	0,00	0,00	0,05	0,46	0,09	0,35	0,06	0,83	0,03	0,01	0,26	0,40	0,19	0,77	0,77	0,33	1,68	1,99	0,00	0,00	0,00	0,18	0,06	0,10	0,18	0,04	0,09	0,02	0,03	0,08	0,13	0,04	0,06	0,04	0,04	0,07	0,03	0,03	0,09	0,02	0,04	0,03	0,14	0,08	0,00	0,00
max	36,09	36,09	36,06	8,70	36,12	8,61	8,64	8,67	0,15	0,41	0,19	0,31	0,89	30,76	143,54	38,49	16,48	4,93	166,89	4,24	3,47	1700,26	1490,23	526,59	370,24	370,24	1483,15	169,69	202,77	0,00	0,00	0,00	48,57	136,03	80,18	40,26	83,17	44,89	74,63	44,87	49,96	40,75	50,66	44,66	25,49	30,12	133,95	74,48	73,90	53,64	20,80	20,74	21,46	19,99	73,74	25,41	25,82
min	35,87	35,88	35,84	8,59	35,91	8,49	8,53	8,56	0,15	0,41	0,19	0,31	0,88	30,57	141,55	38,11	15,30	4,72	164,09	4,13	3,41	1699,14	1489,00	525,97	367,63	367,63	1482,04	162,35	194,05	0,00	0,00	0,00	47,76	135,84	79,81	39,71	83,03	44,59	74,57	44,77	49,67	40,32	50,52	44,56	25,35	29,99	133,67	74,37	73,82	53,32	20,71	20,60	21,34	19,55	73,47	25,40	25,80
max - min	0,21	0,21	0,22	0,11	0,21	0,12	0,12	0,11	0,01	0,00	0,00	0,00	0,01	0,18	2,00	0,38	1,18	0,22	2,80	0,11	0,06	1,12	1,30	0,62	2,61	2,61	1,14	7,34	8,71	0,00	0,00	0,00	0,81	0,20	0,11	0,29	0,43	0,15	0,21	0,15	0,15	0,13	0,28	0,11	0,09	0,31	0,09	0,13	0,12	0,44	0,27	0,00	0,01				

Measurement 8f)																																																									
description	parallel coupled condensers Q1 & Q2, 0,97l/s Q1 and 0,24l/s Q2, water flow for sub cooler Q3 and oil cooler Q4 as in measurement 7a)																																																								
compressor capacity	60,0%	liq. Level 75%																																																							
cold water pump	29,5 Hz																																																								
hot water pump	not noted																																																								
file	2013-06-10_01_svedanvp_08.txt																																																								
date, time	2013-06-10, 14:09																																																								
no. of data points	70																																																								
average	35,78	35,79	35,76	8,61	35,82	8,52	8,55	8,58	0,15	0,41	0,19	0,24	0,97	30,66	151,08	29,61	15,80	4,78	165,39	4,19	3,45	1698,71	1489,58	524,78	367,79	367,79	1482,65	166,54	198,82	0,00	0,00	0,00	48,00	135,48	80,00	40,00	81,97	44,68	74,35	44,78	49,70	40,54	50,47	44,53	25,43	30,06	133,30	74,15	73,65	53,34	20,65	20,57	21,34	19,66	73,36	25,35	25,72
standard dev.	0,06	0,06	0,06	0,04	0,06	0,04	0,04	0,04	0,00	0,00	0,00	0,00	0,00	0,05	0,57	0,09	0,37	0,07	0,82	0,03	0,01	0,21	0,39	0,05	0,85	0,85	0,32	1,61	1,91	0,00	0,00	0,00	0,22	0,03	0,07	0,19	0,02	0,09	0,01	0,03	0,09	0,14	0,03	0,06	0,05	0,04	0,03	0,02	0,01	0,10	0,03	0,04	0,02	0,14	0,08	0,01	0,01
max	35,89	35,88	35,85	8,67	35,92	8,58	8,61	8,64	0,15	0,41	0,19	0,24	0,97	30,76	152,18	29,91	16,35	4,89	166,76	4,26	3,48	1699,06	1490,23	524,90	369,33	369,33	1483,18	169,70	202,58	0,00	0,00	0,00	48,50	135,55	80,16	40,29	82,02	44,83	74,37	44,84	49,84	40,76	50,53	44,62	25,50												

Appendix C – Liquid Pump Characteristic

RC2-7/4 Performance

